



Binding Post Terminal Connectors 95A Outer Screw(M8)
Red

Part Number:

RHT-TMH-M8-4-R

Basic Information

Body Style	Cylinder
Color	Red

Material Specification

Contact Finish	Nickel Plating
Contact Material	Brass
Flammability	UL94 V-0
Insulation Material	ABS

Mechanical Specification

Contact Termination	Screw
Docking Method	Thread
Insertion Times	> 500
Mounting Feature	Through Hole
Mounting Type	Panel Mount
Termination Thread	M8

Electrical Specification

Dielectric Strength	3000V
Rated Current	95A
Rated Voltage	500V

Environmental Specification

Operating Temperature	-40°C to +125°C
-----------------------	-----------------

Size

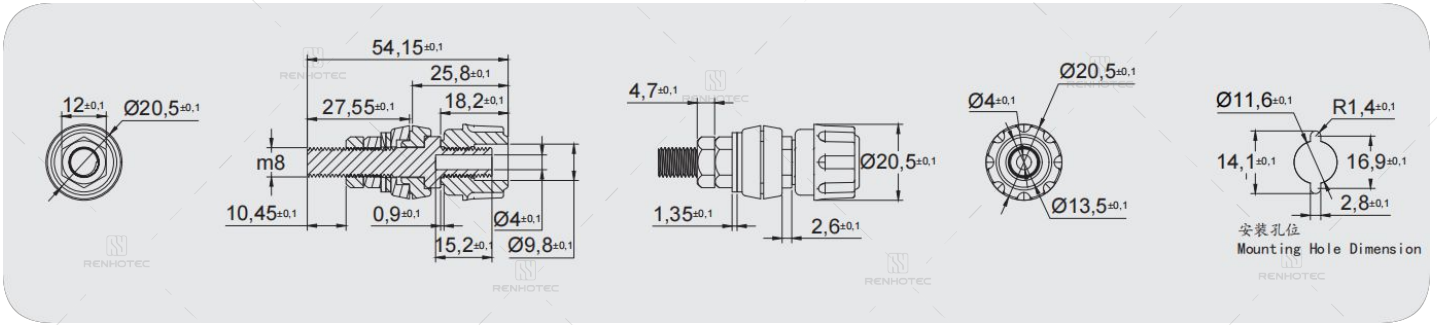

How to Order

1. Specify the upper and lower mounting thread specifications.
2. Specify the panel cutout shape.
4. Specify whether waterproofing is required.
1. Specify the rated current.
5. Specify whether a protective cap is needed.
6. Specify the main body color.

FOR EXAMPLE:

The product with an installation end M8 internal thread structure, a two-ear flange mounting base, a 500A rated current, and an insulation protective cover has the part number RHT-FM8-3457-32-500A-C.

Disclaimer

The information in this specification is subject to change without notice. Please confirm the latest version before use. Technical parameters are for reference only, and sufficient testing and verification should be conducted in actual applications.