



J30J Series (or MIL-DTL-83513 / MDM)

Miniature Rectangular Electronic Connector

J30J Series (or MIL-DTL-83513 / MDM)

Description

J30J Miniature Rectangular Electronic Connector Series Micro D Connector is a small electrical connector. This product performance comply with GJB2446(general specification for micro-miniature polarized shell rectangular electrical connectors), it is equivalent MIL-DTL-83513, it is divided to common(shell) and improved(shell). With the small install space, light weight , reliable connect, excellent electromagnetic scree,good earthquake resistance, etc. It is widely used in small space required electronic equipment and apparatus.

Main Specifications

- **Operating Temperature:** -55°C to +125°C
- **Rated Current:** 3A
- **Humidity:** 98% at +40°C
- **Insulation resistance:** $\geq 5000\text{M}\Omega$
- **Contact resistance:** $\leq 10\text{m}\Omega$
- **Durability:** 500 times
- **Dielectric Strength:** 800 V
- **Vibration:** 10Hz ~ 2000Hz 196 m/s²
- **Random Vibration:** Power density 0.4G²/Hz. The total acceleration-root-mean square is 23.1G
- **Shock:** 735 m/s², 11ms
- **Acceleration:** 735 m/s²
- **Low air pressure:** 4.5 kPa 200V

How to order

	J30J	X	TJ/ZK	X	X	X	X
J30J series							
Number of contacts: 9, 15, 21, 25, 31, 37, 51, 66, 74, 100							
Connector and contact type: TJ - Plug with pins ZK - Receptacle with socket TJ/ZK - Fixation combinaton							
Type of contact terminal: Null - Crimp S - Solder N - Straight inserting PCB W - Right angle inserting PCB							
Type of locking subassemblies: Check more details in J30J locking subassemblies							
Finishing: Null - Shell plated with nickel G - Shell plated with cadmium							
Improved type: A - Shell with shielding braid cable clipper C - Suitable for contact and wire is right angle D - There is spinning-resistance groove in the interface terminal of the receptacle shell flange AD - The combination of variation A and D J - The grid of PCB is 1.27×2.54 (row*line) Q - The shell flange is widened							

J30J Micro-D Connector Pinout

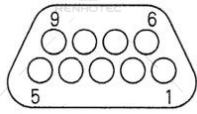

J30J-9

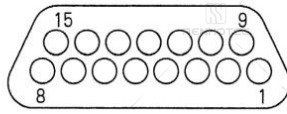

J30J-15

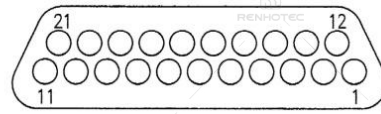

J30J-21

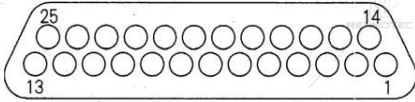

J30J-25

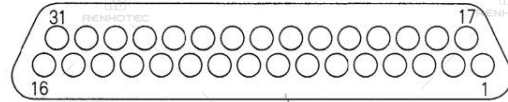

J30J-31

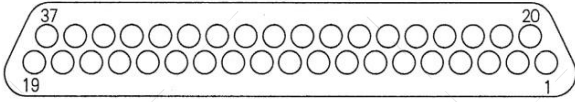

J30J-37

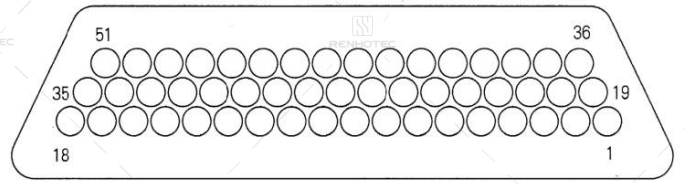

J30J-51

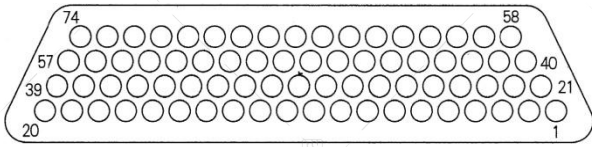

J30J-74

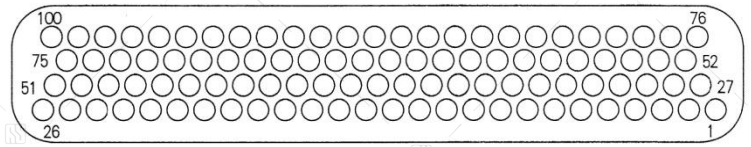

J30J-100

Shell size

Type: crimp

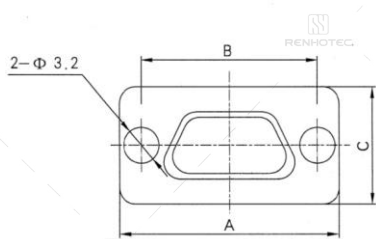
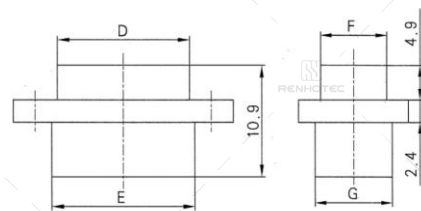
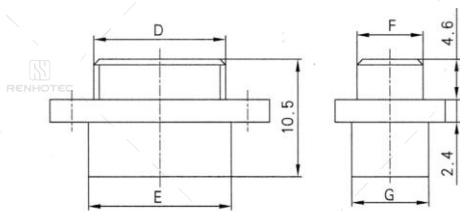

plug with pin

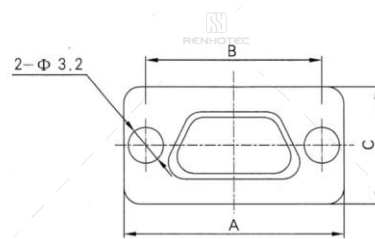

receptacle with socket

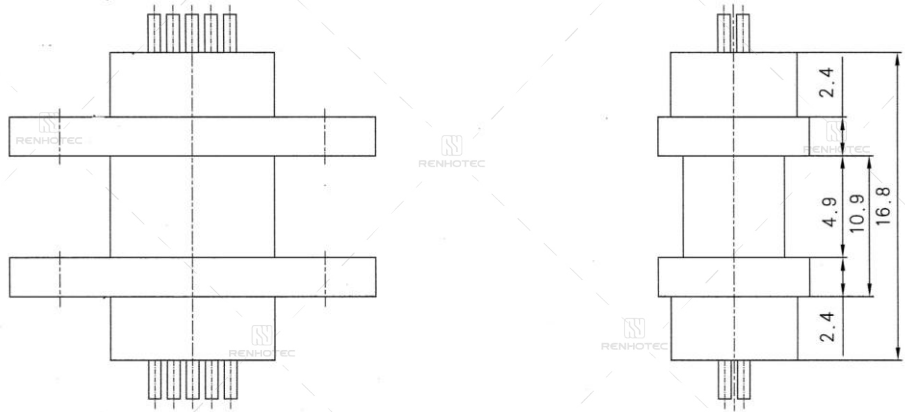

Size after mating

Part number	A	B	C	D	E	F	G
J30J-9TJ	19.6	14.3	7.6	8.3	9.9	4.7	6.8
J30J-15TJ	23.5	18.2	7.6	12.3	13.8	4.7	6.8
J30J-21TJ	27.4	22.0	7.6	16.0	17.6	4.7	6.8
J30J-25TJ	29.8	24.5	7.6	18.6	20.2	4.7	6.8
J30J-31TJ	33.6	28.3	7.6	22.4	24.0	4.7	6.8
J30J-37TJ	37.4	32.2	7.6	26.3	27.8	4.7	6.8
J30J-51TJ	36.4	30.86	8.7	25.0	26.6	5.8	7.9
J30J-66TJ	42.9	37.3	8.7	31.4	33.0	5.8	7.9
J30J-74TJ	38.8	33.5	9.7	27.5	29.1	6.8	9.1
J30J-100TJ	54.7	45.7	9.7	35.0	36.6	6.8	9.1
J30J-9ZK	19.6	14.3	7.6	9.8	9.9	6.1	6.8
J30J-15ZK	23.5	18.2	7.6	13.7	13.8	6.1	6.8
J30J-21ZK	27.4	22.0	7.6	17.4	17.6	6.1	6.8
J30J-25ZK	29.8	24.5	7.6	20	20.2	6.1	6.8
J30J-31ZK	33.6	28.3	7.6	23.8	24.0	6.1	6.8
J30J-37ZK	37.4	32.2	7.6	27.7	27.8	6.1	6.8
J30J-51ZK	36.4	30.86	8.7	26.5	26.6	7.2	7.9
J30J-66ZK	42.9	37.3	8.7	32.9	33.0	7.2	7.9
J30J-74ZK	38.8	33.5	9.7	29.0	29.1	8.3	9.1
J30J-100ZK	54.7	45.7	9.7	36.6	36.6	8.2	9.1

Type: solder

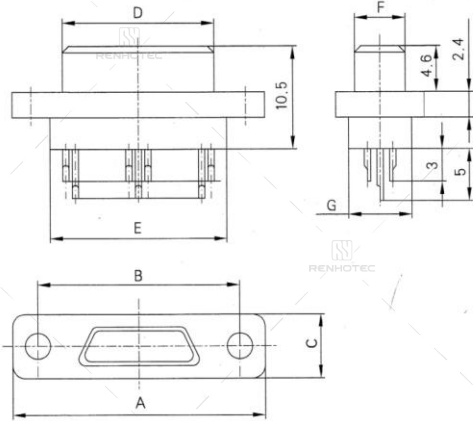

plug with pin

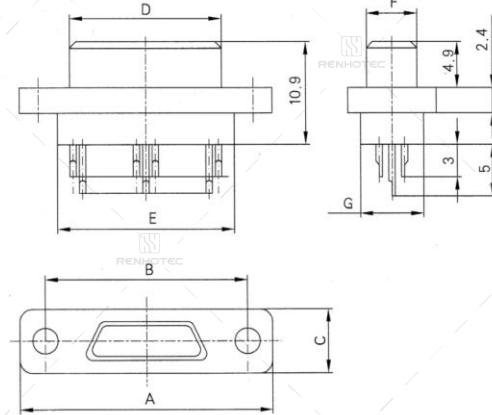

receptacle with socket

Part number	A	B	C	D		E	F		G
J30J-9TJS/ZKS	19.6	14.3	7.6	8.3 (TJS)	9.8 (ZKS)	9.9	4.7	6.1	6.8
J30J-15TJS/ZKS	23.5	18.2	7.6	12.3 (TJS)	13.7 (ZKS)	13.8	4.7	6.1	6.8
J30J-21TJS/ZKS	27.4	22.0	7.6	16.0 (TJS)	17.4 (ZKS)	17.6	4.7	6.1	6.8
J30J-25TJS/ZKS	29.8	24.5	7.6	18.6 (TJS)	20.0 (ZKS)	20.2	4.7	6.1	6.8
J30J-31TJS/ZKS	33.6	28.3	7.6	22.4 (TJS)	23.8 (ZKS)	24.0	4.7	6.1	6.8
J30J-37TJS/ZKS	37.4	32.2	7.6	26.3 (TJS)	27.7 (ZKS)	27.8	4.7	6.1	6.8
J30J-51TJS/ZKS	36.4	30.8	8.7	25.0 (TJS)	26.5 (ZKS)	26.6	5.8	7.2	7.9
J30J-66TJS/ZKS	42.9	37.3	8.7	31.4 (TJS)	32.9 (ZKS)	33.0	5.8	7.2	7.9
J30J-74TJS/ZKS	38.8	33.5	9.7	27.5 (TJS)	29.0 (ZKS)	29.1	6.8	8.3	9.1
J30J-100TJS/ZKS	54.7	45.7	9.7	35.0 (TJS)	36.6 (ZKS)	36.6	6.8	8.3	9.1

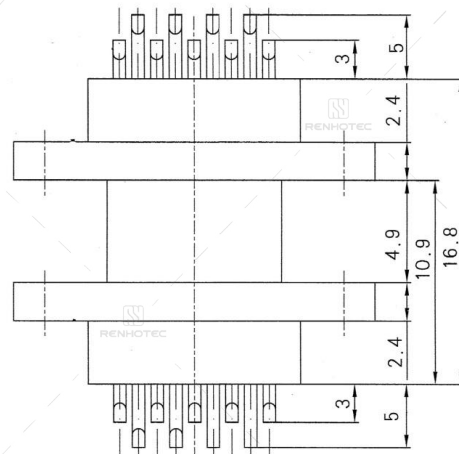
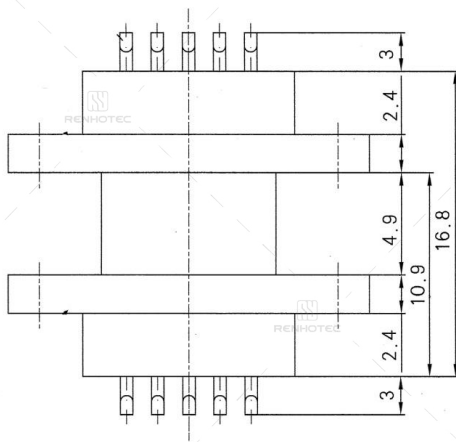

Size after mating

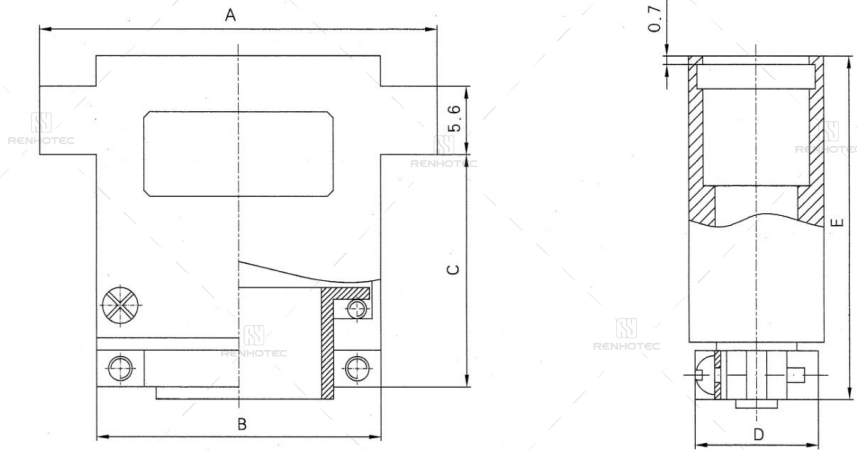

Size of A3 clamp

Type (Cores)	A	B	C	D	E	Type (Cores)	A	B	C	D	E
9	19.6	9.9	18.2	10.4	27	37	37.4	27.8	19.2	10.4	28
15	23.5	13.8	18.2	10.4	27	51	36.4	26.6	21.2	11.2	30
21	27.4	17.6	19.2	10.4	28	66	42.9	33.0	21.2	11.2	30
25	29.8	20.2	19.2	10.4	28	74	38.8	29.1	21.2	12.0	30
31	33.6	24.0	19.2	10.4	28	100	54.7	40.7	21.2	12.0	30

Type: straight PCB

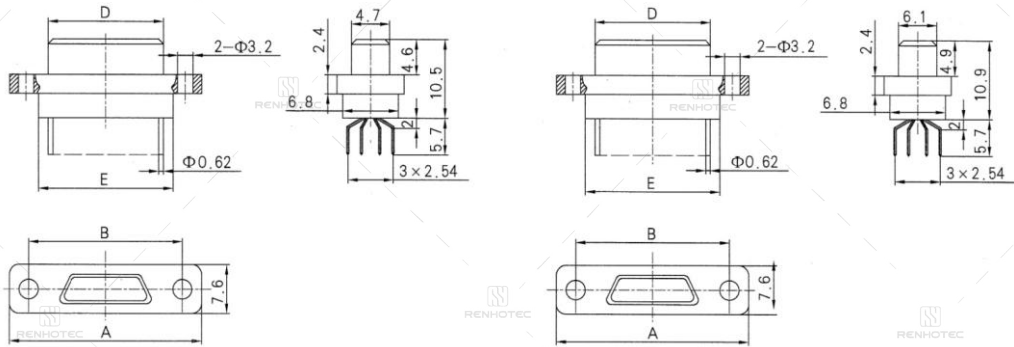

Grid Distance: 2.54*2.54 cores:9, 15, 21, 25, 31, 37

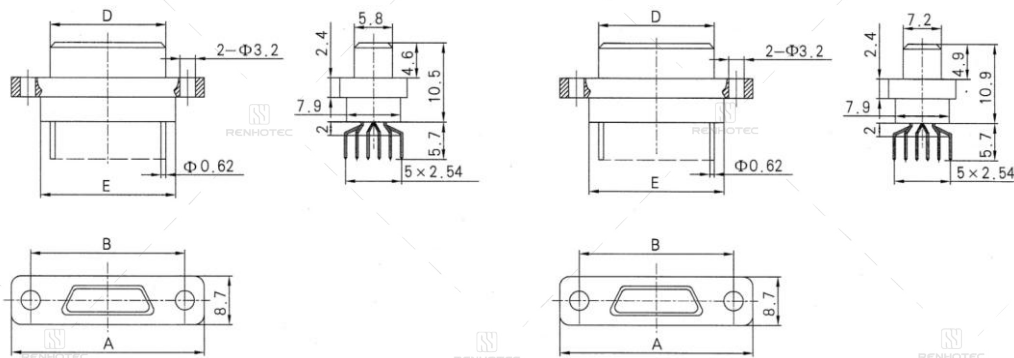

Grid Distance: 2.54*2.54 cores:51, 66

Part number	A	B	C	D		E
J30J-9TJN/ZKN	19.6	14.3	7.6	8.3 (TJN)	9.8 (ZKN)	9.9
J30J-15TJN/ZKN	23.5	18.2	7.6	12.3 (TJN)	13.7 (ZKN)	13.8
J30J-21TJN/ZKN	27.4	22.0	7.6	16.0 (TJN)	17.4 (ZKN)	17.6
J30J-25TJN/ZKN	29.8	24.5	7.6	18.6 (TJN)	20.0 (ZKN)	20.2
J30J-31TJN/ZKN	33.6	28.3	7.6	22.4 (TJN)	23.8 (ZKN)	24.0
J30J-37TJN/ZKN	37.4	32.2	7.6	26.3 (TJN)	27.7 (ZKN)	27.8
J30J-51TJN/ZKN	36.4	30.8	8.7	25.0 (TJN)	26.5 (ZKN)	26.6
J30J-66TJN/ZKN	42.9	37.3	8.7	31.4 (TJN)	32.9 (ZKN)	33.0

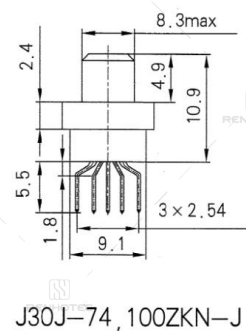
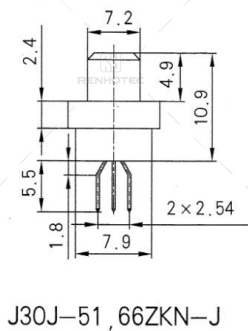
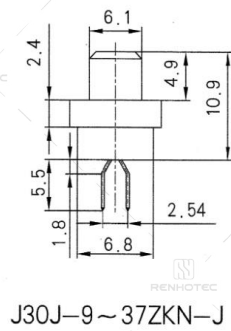
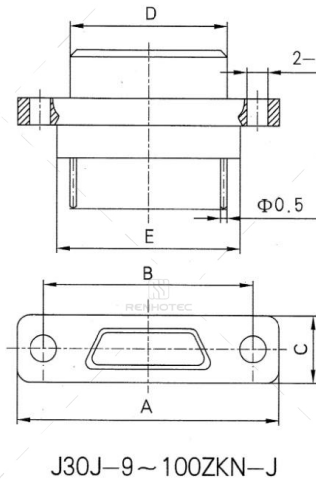
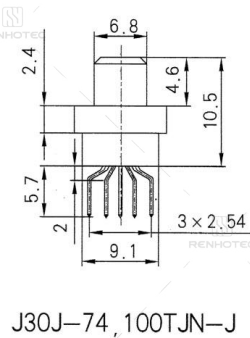
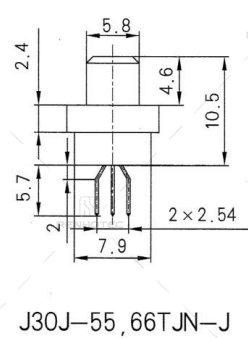
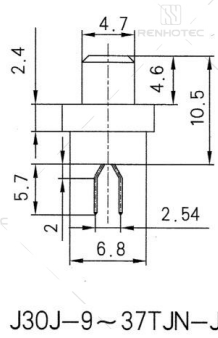
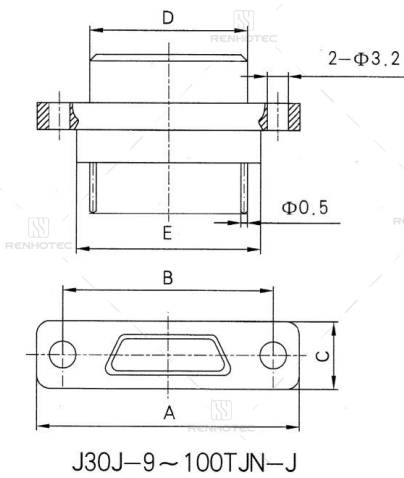

Grid Distance: 1.27*2.54

Part number	A	B	C	D		E
J30J – 9TJN/ZKN – J	19.6	14.3	7.6	8.3 (TJN – J)	9.8 (ZKN – J)	9.9
J30J – 15TJN/ZKN – J	23.5	18.2	7.6	12.3 (TJN – J)	13.7 (ZKN – J)	13.8
J30J – 21TJN/ZKN – J	27.4	22.0	7.6	16.0 (TJN – J)	17.4 (ZKN – J)	17.6
J30J – 25TJN/ZKN – J	29.8	24.5	7.6	18.6 (TJN – J)	20.0 (ZKN – J)	20.2
J30J – 31TJN/ZKN – J	33.6	28.3	7.6	22.4 (TJN – J)	23.8 (ZKN – J)	24.0
J30J – 37TJN/ZKN – J	37.4	32.2	7.6	26.3 (TJN – J)	27.7 (ZKN – J)	27.8
J30J – 51TJN/ZKN – J	36.4	30.8	8.7	25.0 (TJN – J)	26.5 (ZKN – J)	26.6
J30J – 66TJN/ZKN – J	42.9	37.3	8.7	31.4 (TJN – J)	32.9 (ZKN – J)	33.0
J30J – 74TJN/ZKN – J	38.8	33.5	9.7	27.5 (TJN – J)	29.0 (ZKN – J)	29.1
J30J – 100TJN/ZKN – J	54.7	45.7	9.7	35.0 (TJN – J)	36.6 (ZKN – J)	36.6

Type: 90° elbow PCB

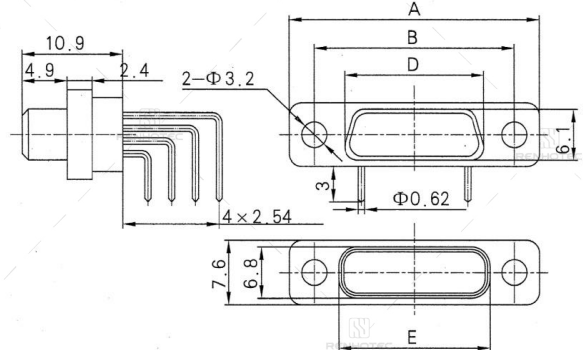
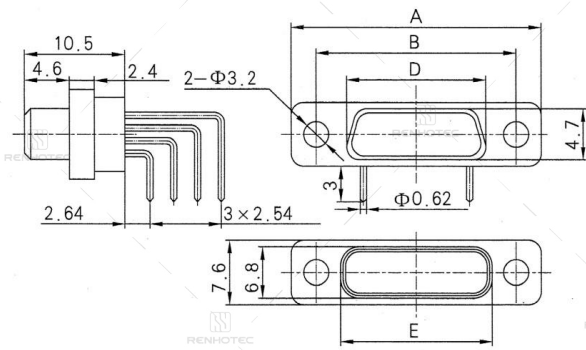

Grid Distance: 2.54*2.54 cores: 9, 15, 21, 25, 31, 37

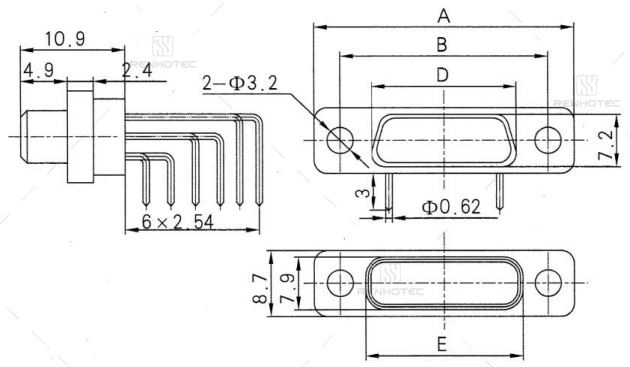
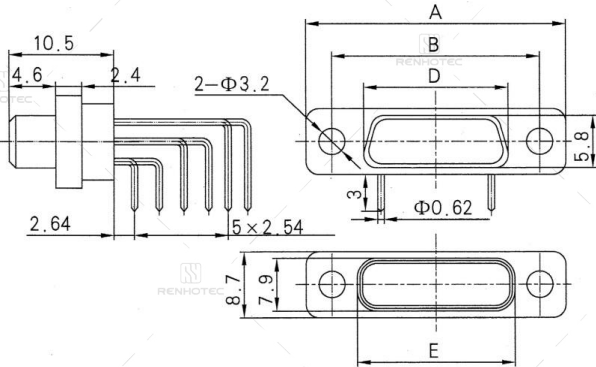

Grid Distance: 2.54*2.54 cores: 51, 66

Part number	A	B	D		E
J30J – 9TJW/ZKW	19.6	14.30	8.3 (TJW)	9.8 (ZKW)	9.9
J30J – 15TJW/ZKW	23.5	18.20	12.3 (TJW)	13.7 (ZKW)	13.8
J30J – 21TJW/ZKW	27.4	22.00	16.0 (TJW)	17.4 (ZKW)	17.6
J30J – 25TJW/ZKW	29.8	24.50	18.6 (TJW)	20.0 (ZKW)	20.2
J30J – 31TJW/ZKW	33.6	28.30	22.4 (TJW)	23.8 (ZKW)	24.0
J30J – 37TJW/ZKW	37.4	32.20	26.3 (TJW)	27.7 (ZKW)	27.8
J30J – 51TJW/ZKW	36.4	30.86	25.0 (TJW)	26.5 (ZKW)	26.6
J30J – 66TJW/ZKW	42.9	37.30	31.4 (TJW)	32.9 (ZKW)	33.0

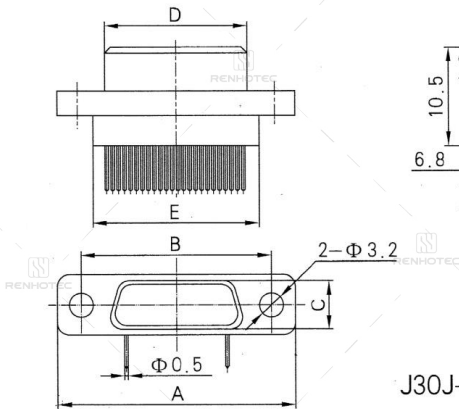

J30J-9~100TJW-J

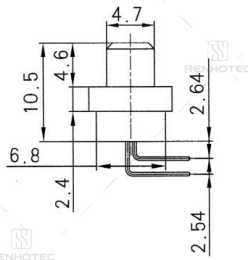

J30J-9~37TJW-J

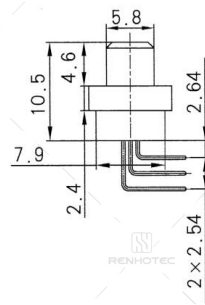

J30J-51, 66TJW-J

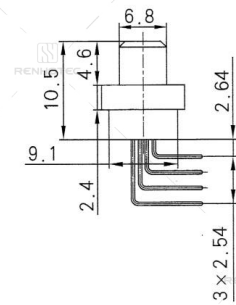

J30J-74, 100TJW-J

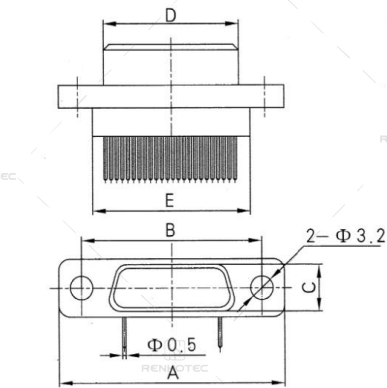

J30J-9~100ZKW-J

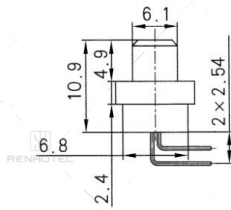

J30J-9~37ZKW-J

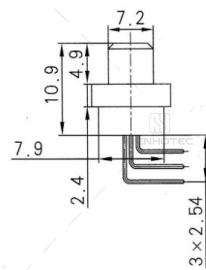

J30J-51, 66ZKW-J

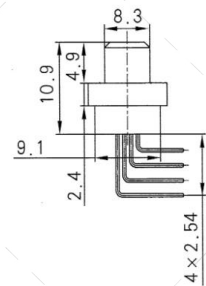

J30J-74, 100ZKW-J

Grid Distance: 1.27*2.54

Part number	A	B	C	D		E
J30J – 9TJW/ZKW – J	19.6	14.3	7.6	8.3 (TJW – J)	9.8 (ZKW – J)	9.9
J30J – 15TJW/ZKW – J	23.5	18.2	7.6	12.3 (TJW – J)	13.7 (ZKW – J)	13.8
J30J – 21TJW/ZKW – J	27.4	22.0	7.6	16.0 (TJW – J)	17.4 (ZKW – J)	17.6
J30J – 25TJW/ZKW – J	29.8	24.5	7.6	18.6 (TJW – J)	20.0 (ZKW – J)	20.2
J30J – 31TJW/ZKW – J	33.6	28.3	7.6	22.4 (TJW – J)	23.8 (ZKW – J)	24.0
J30J – 37TJW/ZKW – J	37.4	32.2	7.6	26.3 (TJW – J)	27.7 (ZKW – J)	27.8
J30J – 51TJW/ZKW – J	36.4	30.8	8.7	25.0 (TJW – J)	26.5 (ZKW – J)	26.6
J30J – 66TJW/ZKW – J	42.9	37.3	8.7	31.4 (TJW – J)	32.9 (ZKW – J)	33.0
J30J – 74TJW/ZKW – J	38.8	33.5	9.7	27.5 (TJW – J)	29.0 (ZKW – J)	29.1
J30J – 100TJW/ZKW – J	54.7	45.7	9.7	35.0 (TJW – J)	36.6 (ZKW – J)	36.6

Locking accessories

Type: L

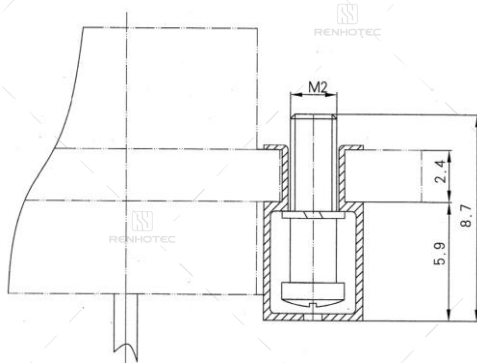

Type: K, K1

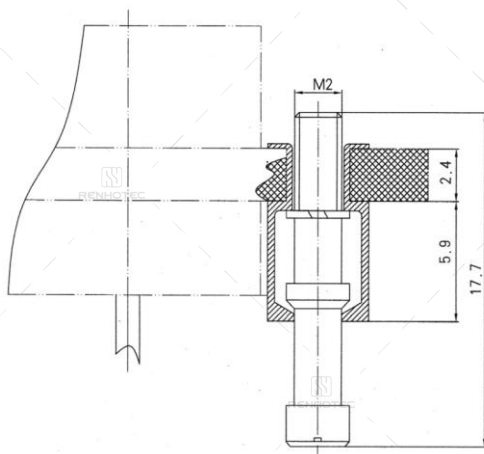

Mark	A
K	M2-6H
K1	0.086-56UNC-2A

Type: P, P1, P8, P9

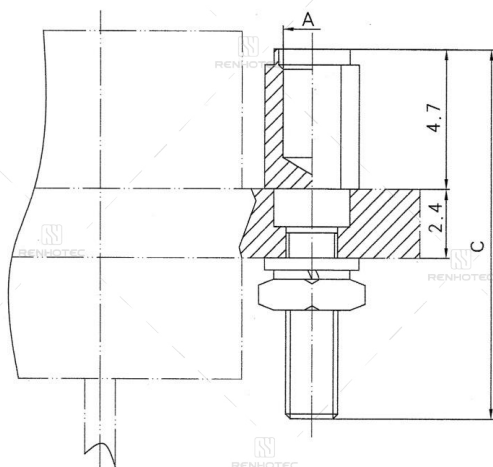

mark	A	B	C
P	M2-6H	M2-6H	12.6
P1	0.086-56UNC-2B	0.086-56UNC-2A	12.6
P8	M2-6H	M2-6H	15.6
P9	M2-6H	M2-6H	21.6

Type: P0, P3, P4, P11

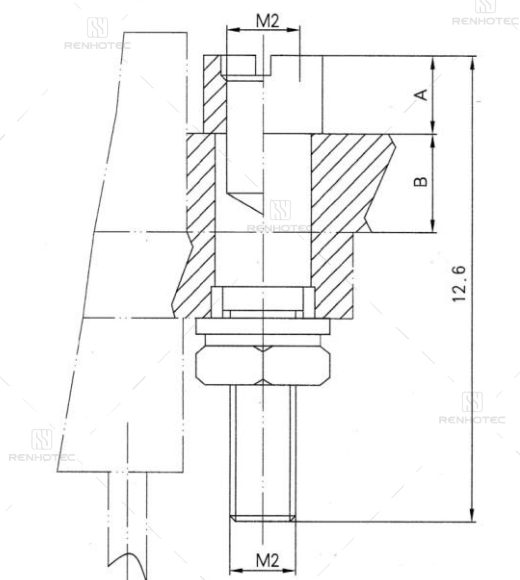

mark	A	B
P0	4.1	0
P3	3.3	1.4
P4	2.5	2.2
P11	1.3	3.4

Type: P2

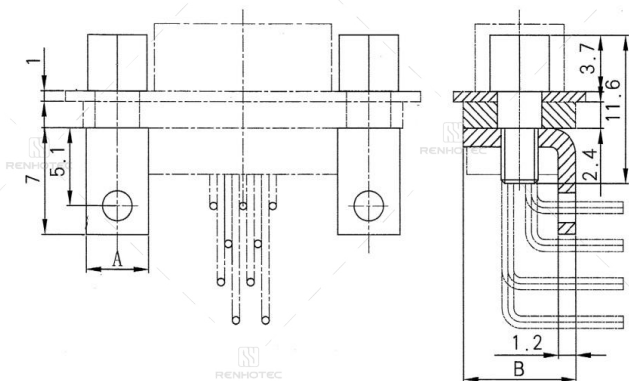

Cores	A	B
9~37	4.2	7.6
51	4.2	8.7
74	4.2	9.7
100	8.8	9.7

Type: P5, P10

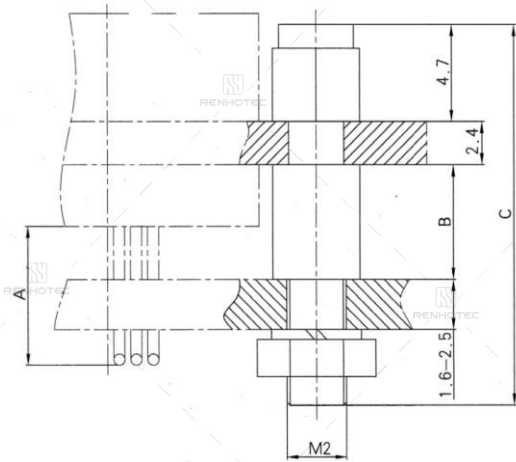

mark	A	B	C
P5	5.7	5.9	18.6
P10	8.0	8.4	20.5

Type: P7

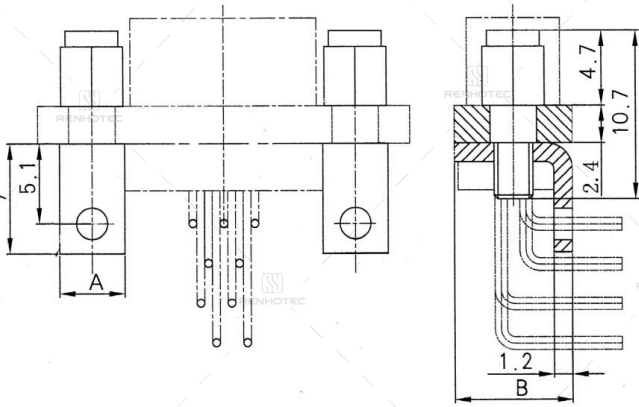

core	A	B
9 ~ 37	4.2	7.6
51	4.2	8.7
74	4.2	9.7
100	8.8	9.7

Type: P14

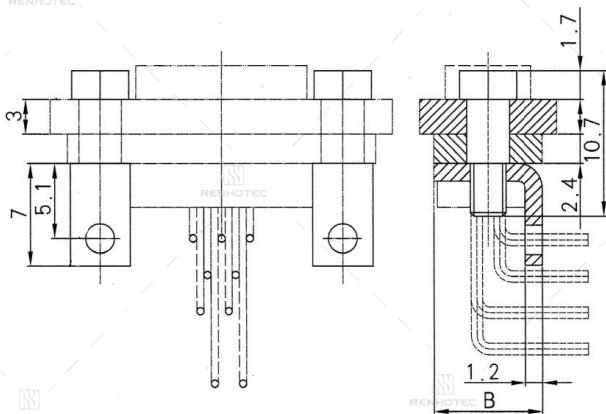

core	A	B
9 ~ 37	4.2	7.6
51	4.2	8.7
74	4.2	9.7
100	8.8	9.7

Type: V

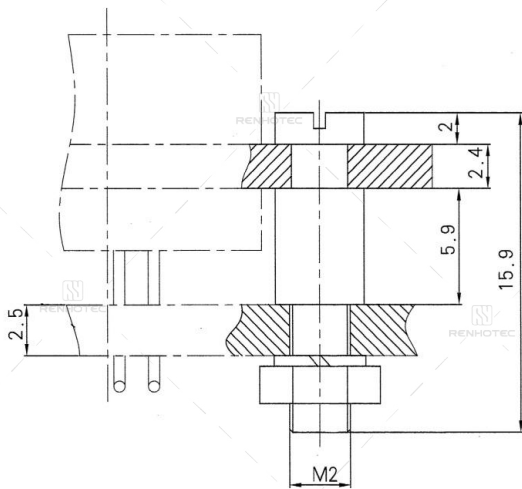

Type: VI

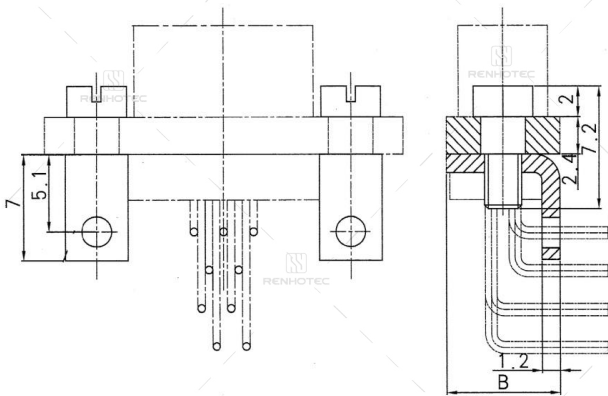

Cores	A	B
9 ~ 37	4.2	7.6
51	4.2	8.7
74	4.2	9.7
100	8.8	9.7

Size of hole

Size of mounting before panel

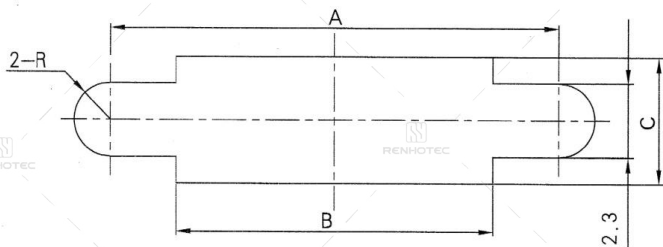



Part number	A	B	C
J30J-9	14.3	10.2	7.0
J30J-15	18.2	14.1	7.0
J30J-21	22.0	17.9	7.0
J30J-25	24.5	20.5	7.0
J30J-31	28.3	24.3	7.0
J30J-37	32.2	28.1	7.0
J30J-51	30.86	26.9	8.1
J30J-66	37.3	33.4	8.1
J30J-74	33.5	29.4	9.3
J30J-100	45.7	37	9.3

Part number	A	B	C
J30J-9-AD	14.3	10.3	8.4
J30J-15-AD	18.2	14.2	8.4
J30J-21-AD	22.0	18.0	8.4
J30J-25-AD	24.5	20.6	8.4
J30J-31-AD	28.3	24.4	8.4
J30J-37-AD	32.2	28.2	8.4
J30J-51-AD	30.86	27.0	9.4
J30J-66-AD	37.3	33.4	9.2
J30J-74-AD	33.5	29.5	11.4
J30J-100-AD	45.7	37.2	11.4

Mark	A	B	C
J30J-9-A	14.3	10.3	8.4
J30J-15-A	18.2	14.2	8.4
J30J-21-A	22.0	18.0	8.4
J30J-25-A	24.5	20.6	8.4
J30J-31-A	28.3	24.4	8.4
J30J-37-A	32.2	28.2	8.4
J30J-51-A	30.86	27.0	9.4
J30J-66-A	37.3	33.4	9.2
J30J-74-A	33.5	29.5	11.4
J30J-100-A	45.7	37.2	11.4

Mark	A	B	C
J30J-9-D	14.3	10.2	7.0
J30J-15-D	18.2	14.1	7.0
J30J-21-D	22.0	17.9	7.0
J30J-25-D	24.5	20.5	7.0
J30J-31-D	28.3	24.3	7.0
J30J-37-D	32.2	28.1	7.0
J30J-51-D	30.86	26.9	8.1
J30J-66-D	37.3	33.4	8.1
J30J-74-D	33.5	29.4	9.3
J30J-100-D	45.7	37.0	9.3

Mark	A	B	C
J30J-9-Q	21.0	10.2	7.0
J30J-15-Q	24.9	14.1	7.0
J30J-21-Q	28.7	17.9	7.0
J30J-25-Q	31.2	20.5	7.0
J30J-31-Q	35.0	24.3	7.0
J30J-37-Q	38.9	28.1	7.0
J30J-51-Q	37.6	26.9	8.1
J30J-66-Q	44.0	33.4	8.1
J30J-74-Q	40.2	29.4	9.3
J30J-100-Q	52.4	37.0	9.3

Size of mounting rear panel

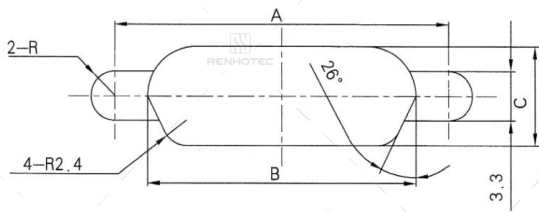

J30J-9, 15, 21, 25, 31, 37, 51, 74

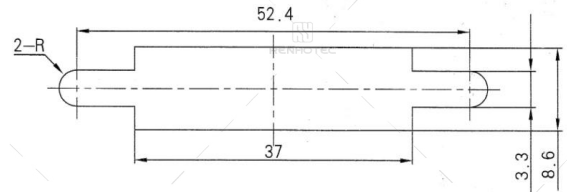

J30J-100TJ-Q/ZK-Q

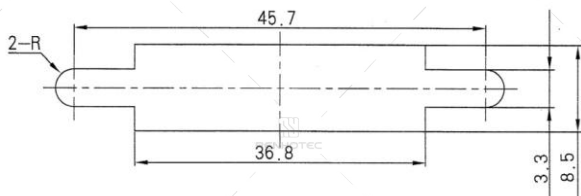

J30J-100TJ/TJ-A/ZK/ZK-A

Pat number	A	B	C
J30J-9	14.30	10.2	6.3
J30J-15	18.20	14.1	6.3
J30J-21	22.00	17.8	6.3
J30J-25	24.50	20.4	6.3
J30J-31	28.30	24.2	6.3
J30J-37	32.20	28.1	6.3
J30J-51	30.86	26.9	7.4
J30J-66	37.30	33.4	7.4
J30J-74	33.50	29.4	8.6

Part number	A	B	C
J30J-9-A	14.3	10.2	6.3
J30J-15-A	18.2	14.1	6.3
J30J-21-A	22.0	17.8	6.3
J30J-25-A	24.5	20.4	6.3
J30J-31-A	28.3	24.2	6.3
J30J-37-A	32.2	28.1	6.3
J30J-51-A	30.86	26.9	7.4
J30J-66-A	37.3	33.4	7.4
J30J-74-A	33.5	29.4	8.6

Part number	A	B	C
J30J-9-Q	21	10.2	6.3
J30J-15-Q	24.9	14.1	6.3
J30J-21-Q	28.7	17.9	6.3
J30J-25-Q	31.2	20.5	6.3
J30J-31-Q	35	24.3	6.3
J30J-37-Q	38.9	28.1	6.3
J30J-51-Q	37.6	26.9	7.4
J30J-66-Q	44	33.4	7.4
J30J-74-Q	40.2	29.4	8.6

J30J PCB Hole dimensions

J30J-xTJN (Grid distance 2.54x2.54)

J30J-9TJN

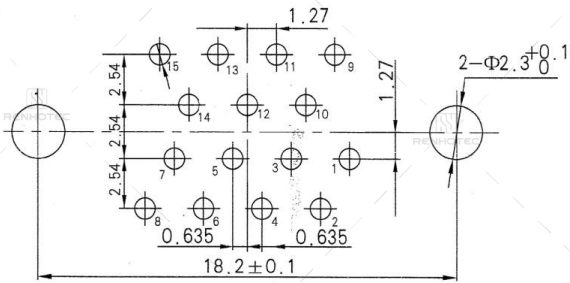

J30J-15TJN

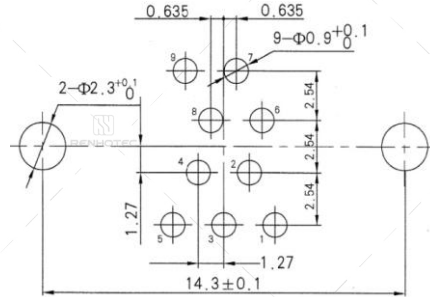

J30J-21TJN

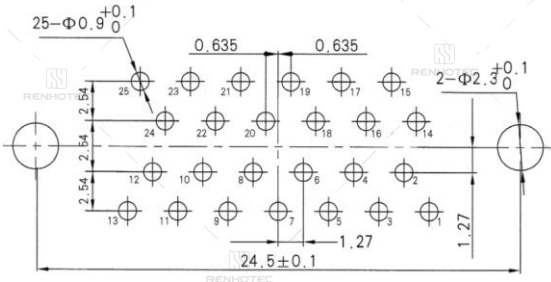

J30J-25TJN

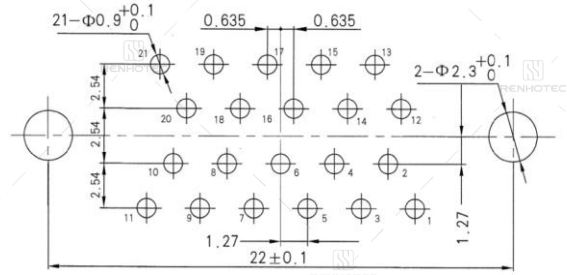

J30J-31TJN

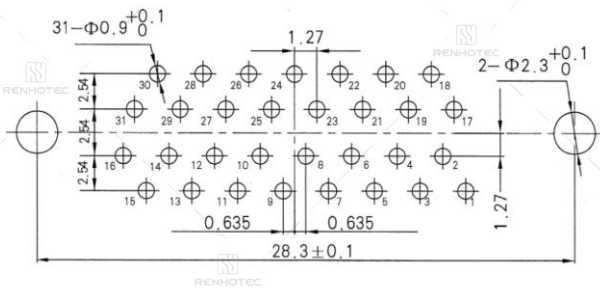

J30J-37TJN

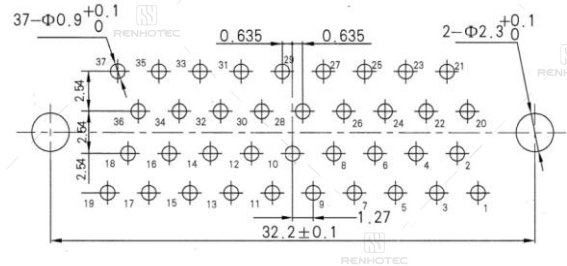

J30J-51TJN

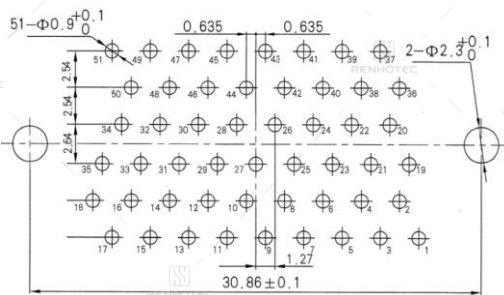

J30J-66TJN

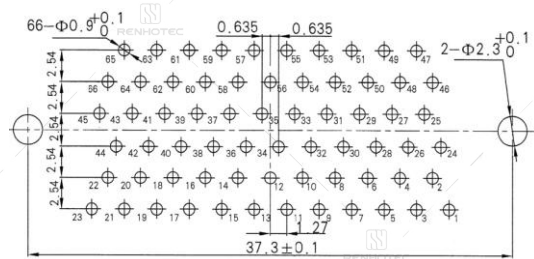

J30J-xZKN(Grid distance 2.54x2.54)

J30J-9ZKN

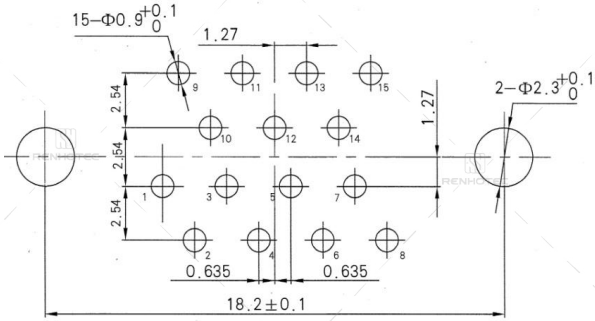

J30J-15ZKN

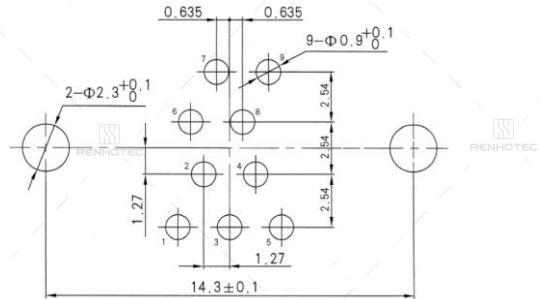

J30J-21ZKN

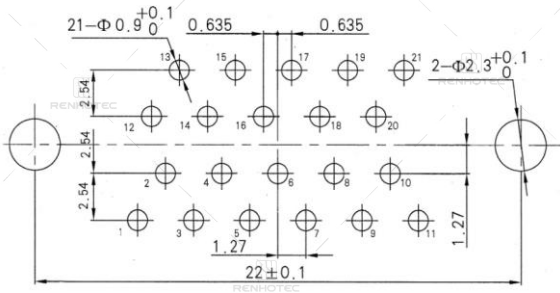

J30J-25ZKN

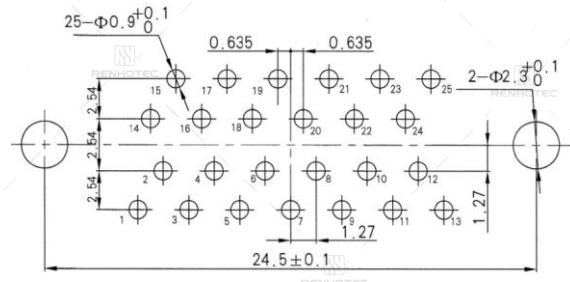

J30J-31ZKN

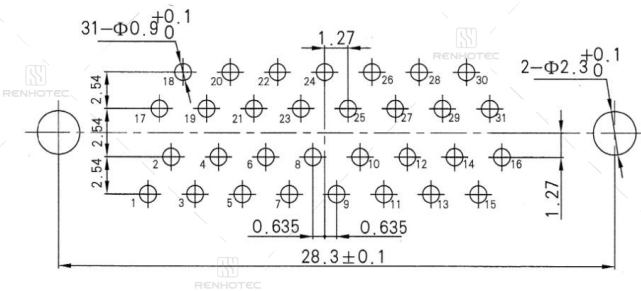

J30J-37ZKN

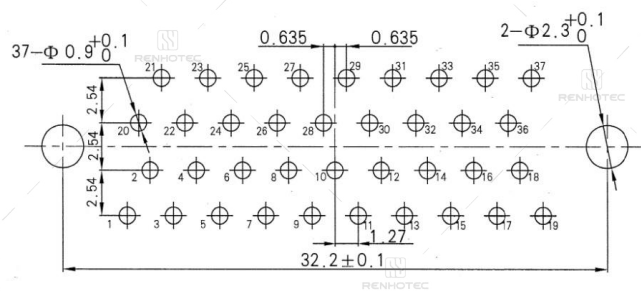

J30J-51ZKN

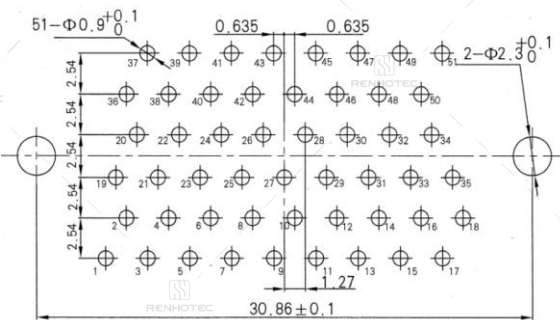

J30J-66ZKN

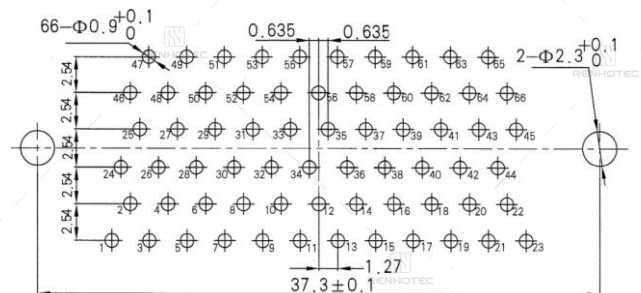

J30J-xTJN-J(Grid distance 1.27x2.54)

J30J-9TJN-J

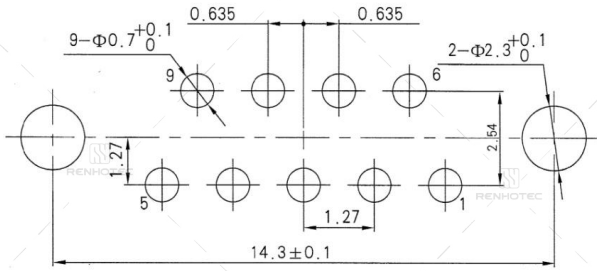

J30J-15TJN-J

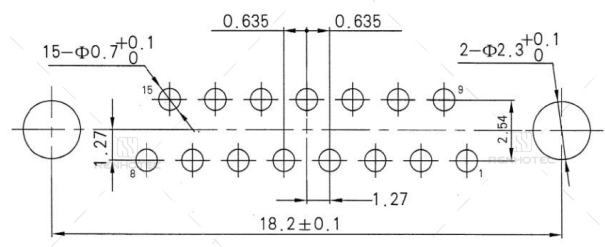

J30J-21TJN-J

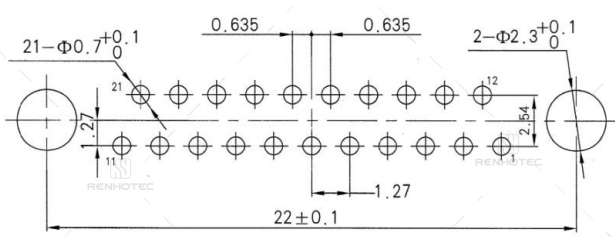

J30J-25TJN-J

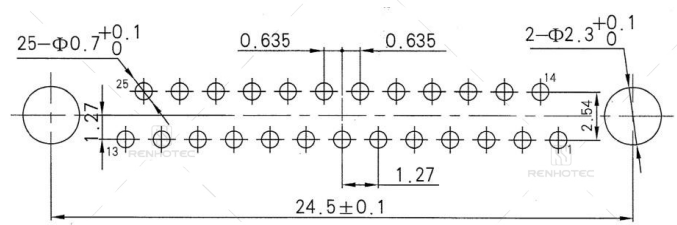

J30J-31TJN-J

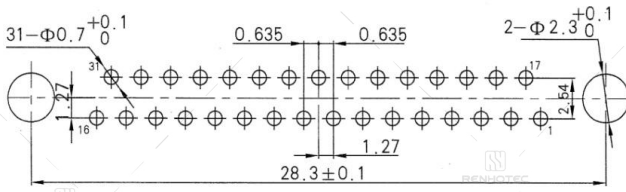

J30J-37TJN-J

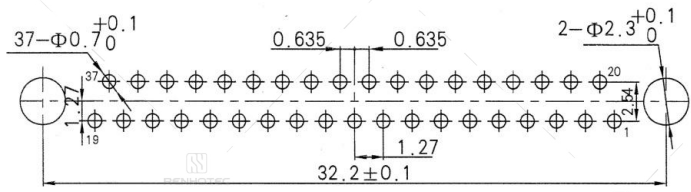

J30J-51TJN-J

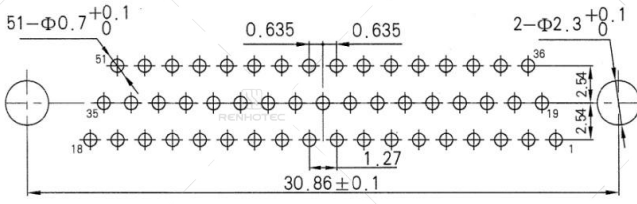

J30J-66TJN-J

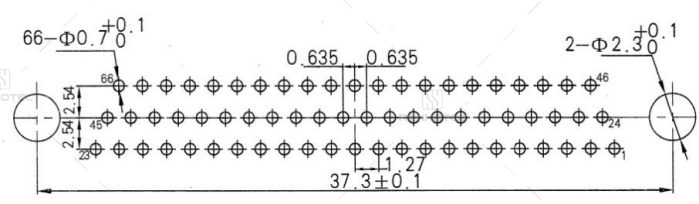

J30J-74TJN-J

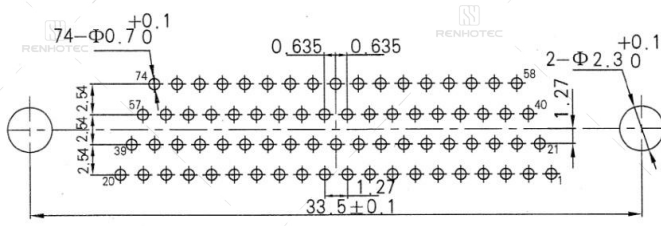

J30J-100TJN-J

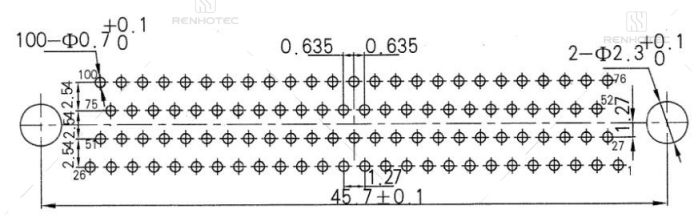

J30J-xZKN-J

J30J-9ZKN-J

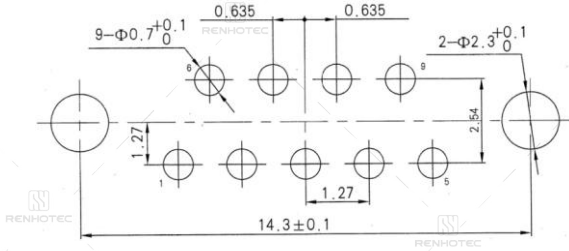

J30J-15ZKN-J

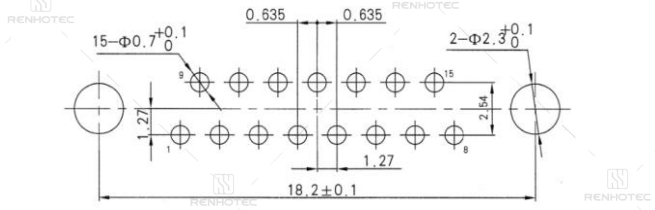

J30J-21ZKN-J

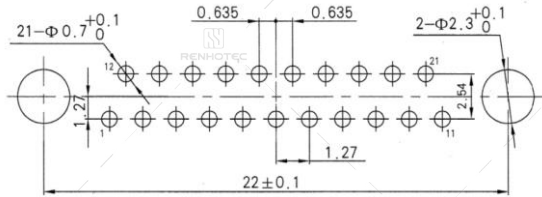

J30J-25ZKN-J

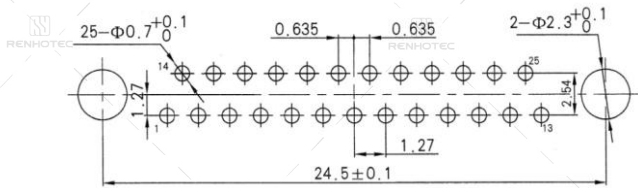

J30J-31ZKN-J

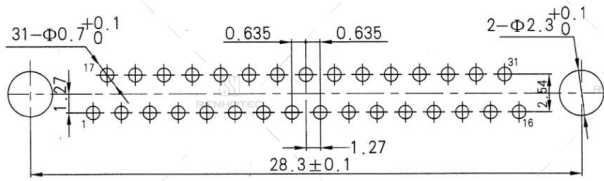

J30J-37ZKN-J

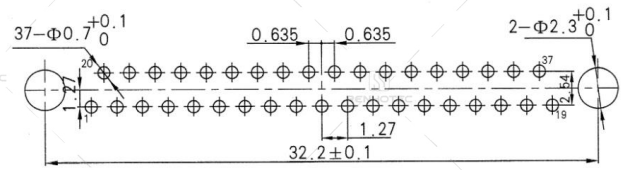

J30J-51ZKN-J

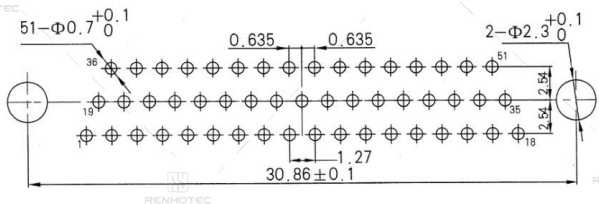

J30J-66ZKN-J

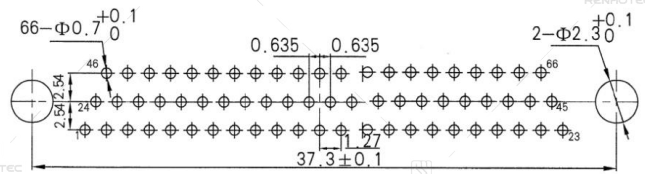

J30J-74ZKN-J

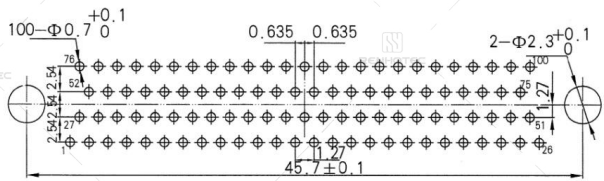

J30J-100ZKN-J

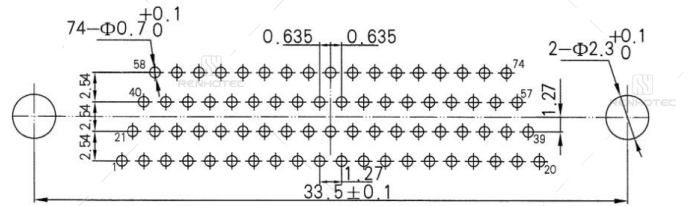

J30J-xTJW (Grid distance 2.54x2.54)

J30J-9TJW

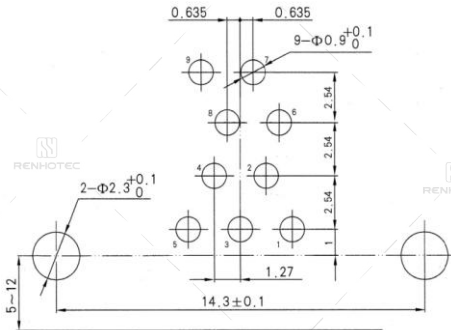

J30J-15TJW

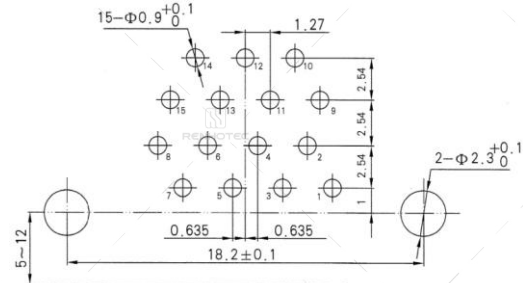

J30J-21TJW

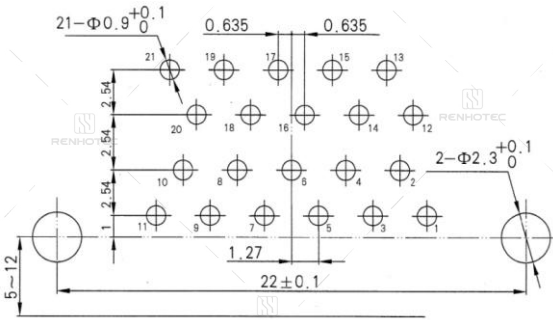

J30J-25TJW

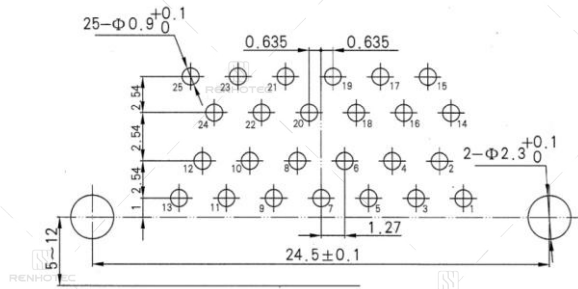

J30J-31TJW

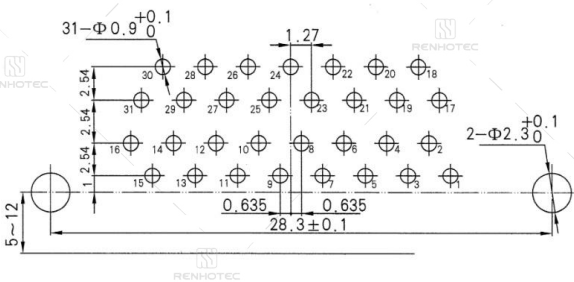

J30J-37TJW

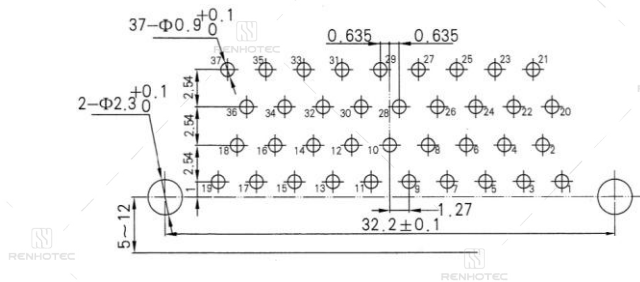

J30J-51TJW

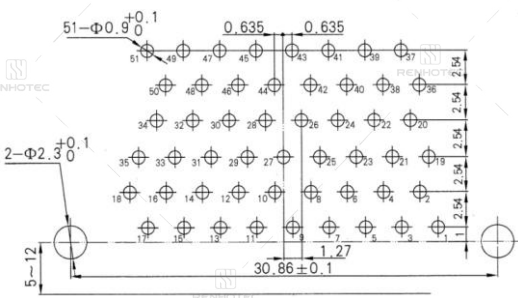

J30J-66TJW

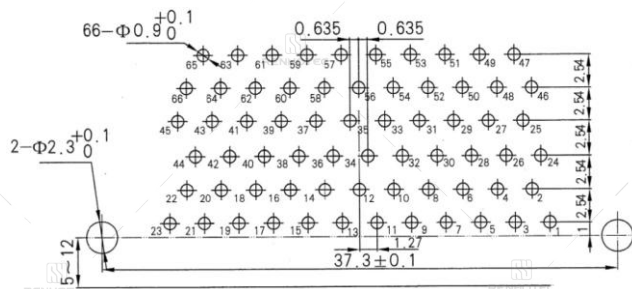

J30J-xZKW (Grid distance 2.54x2.54)

J30J-9ZKW

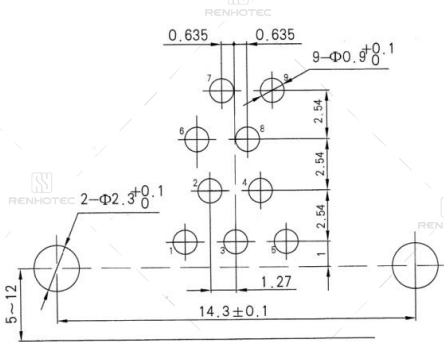

J30J-15ZKW

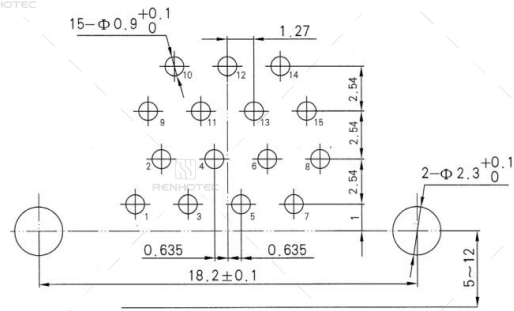

J30J-21ZKW

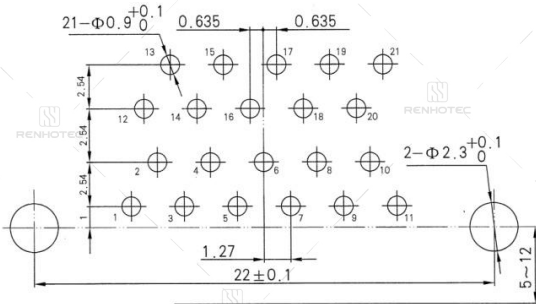

J30J-25ZKW

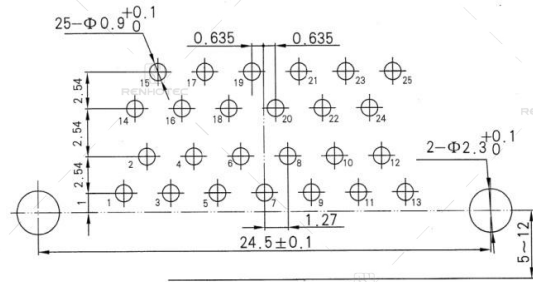

J30J-31ZKW

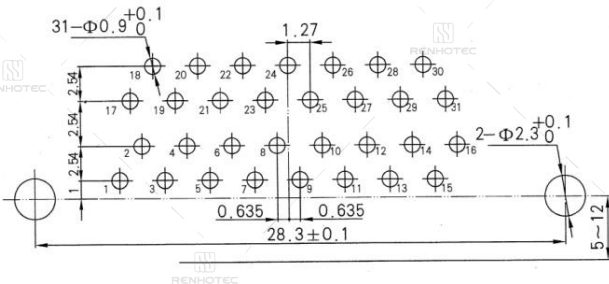

J30J-37ZKW

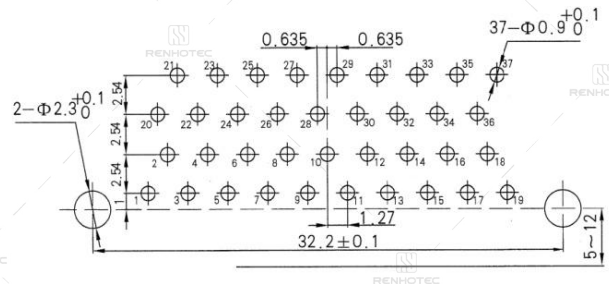

J30J-51ZKW

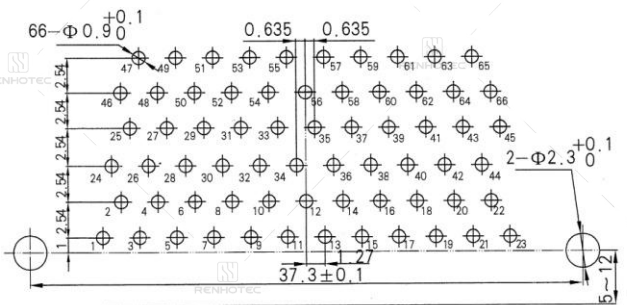

J30J-66ZKW

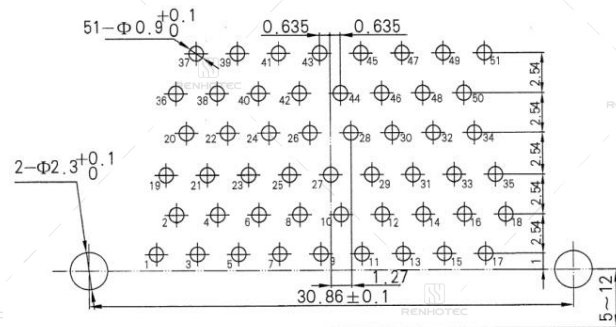

J30J-xTJW-J (Grid distance 1.27x2.54)

J30J-9TJW-J

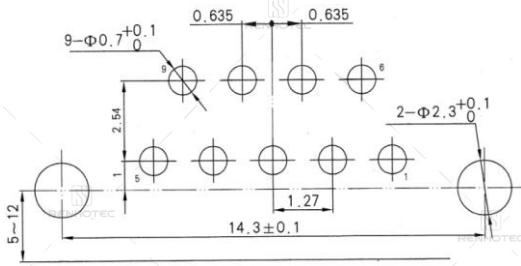

J30J-15TJW-J

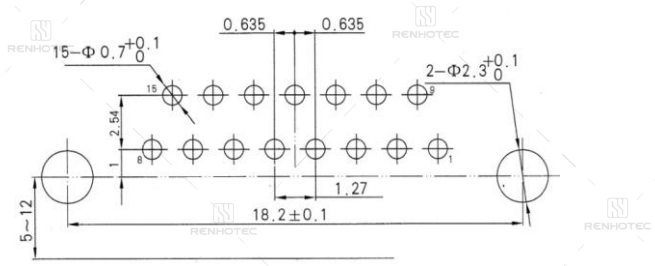

J30J-21TJW-J

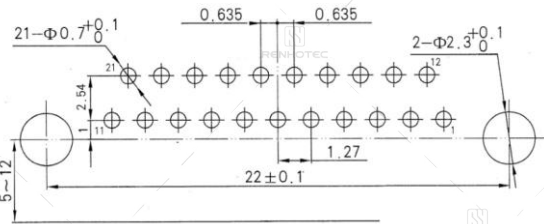

J30J-25TJW-J

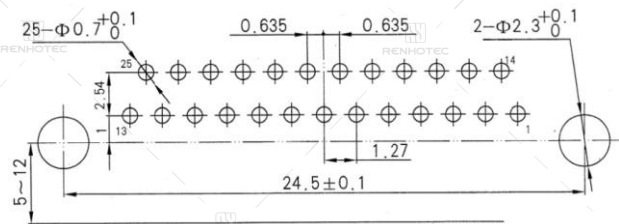

J30J-31TJW-J

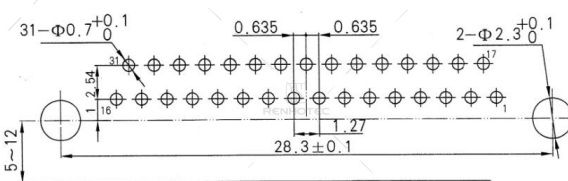

J30J-37TJW-J

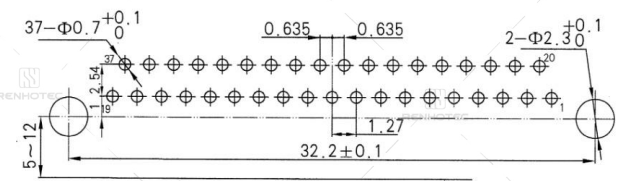

J30J-51TJW-J

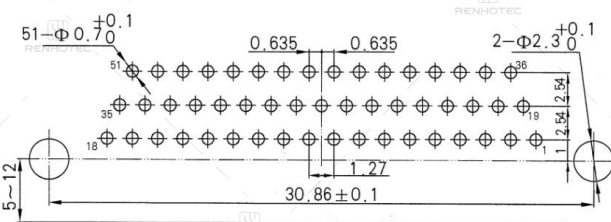

J30J-66TJW-J

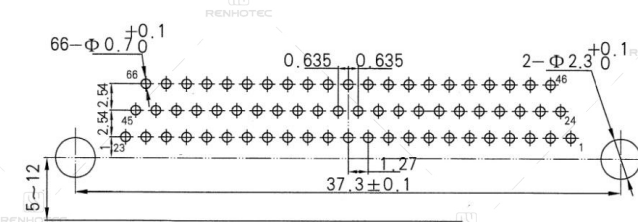

J30J-74TJW-J

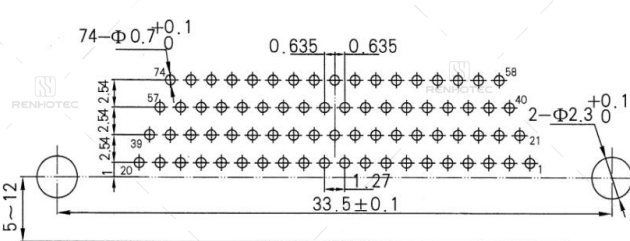

J30J-100TJW-J

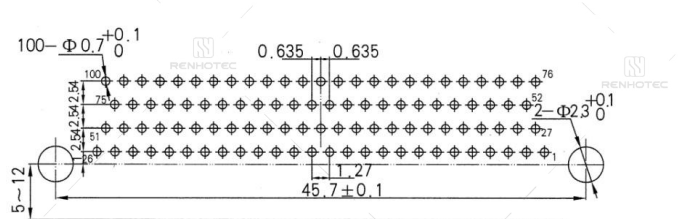

J30J-xZKW-J (Grid distance 1.27x2.54)

J30J-9ZKW-J

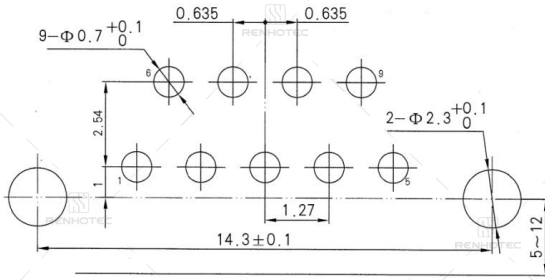

J30J-15ZKW-J

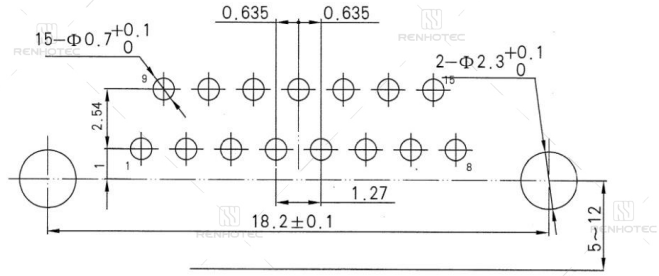

J30J-21ZKW-J

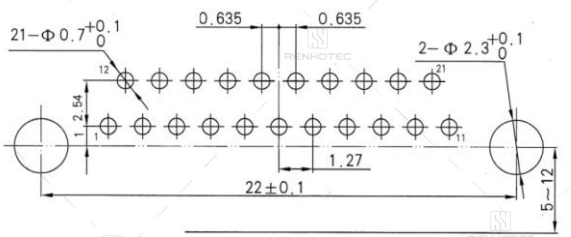

J30J-25ZKW-J

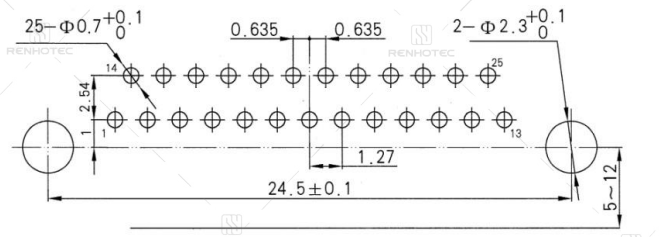

J30J-31ZKW-J

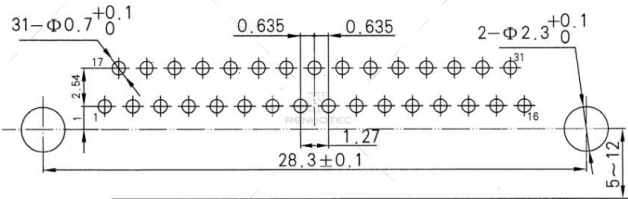

J30J-37ZKW-J

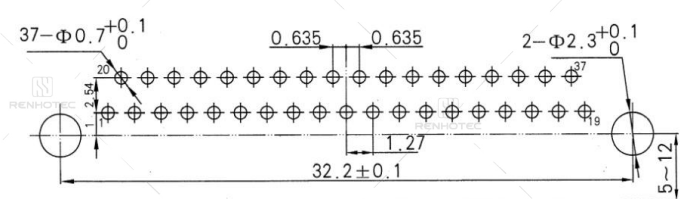

J30J-51ZKW-J

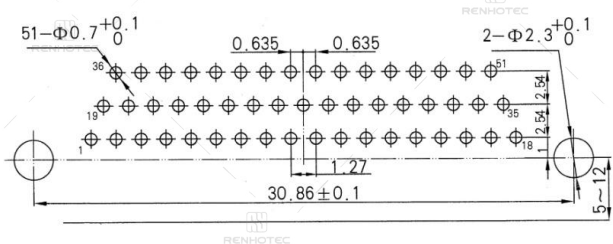

J30J-66ZKW-J

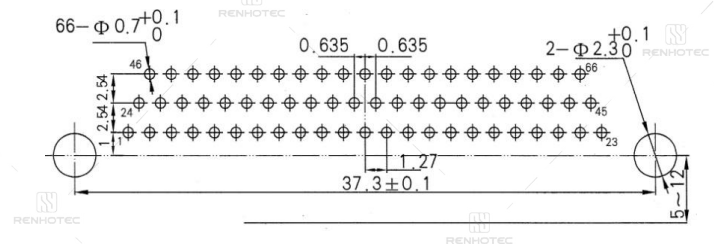

J30J-74ZKW-J

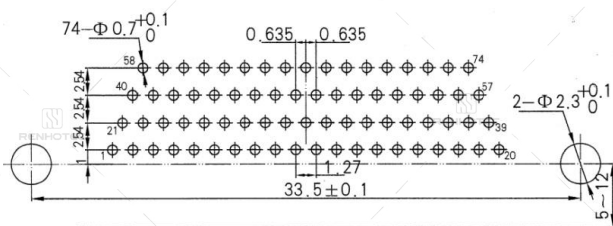

J30J-100ZKW-J

