



Energy Battery Storage Connector Plug Male Right Angle 200A 8mm 50mm² IP67 Red

Part Number:

RHT.P008.C50.RD



Basic Information

Connector Type	Plug
Orientation	Right Angle
Color	Red
Contact Size	8mm
Wire Gauge	50mm ²
Contact Termination	Crimp
Mounting Type	Cable Mount
Mating Cycles	>500

Material Specification

Shell Material	Nylon
Contact Finish	Silver Plating

Environmental Specification

Operating Temperature	-40°C to +125°C
Flammability	UL94 V-0
Ingress Protection	IP67

Electrical Specification

Rated Current	200A
Rated Voltage	1000V
Insulation Resistance	≥1000MΩ

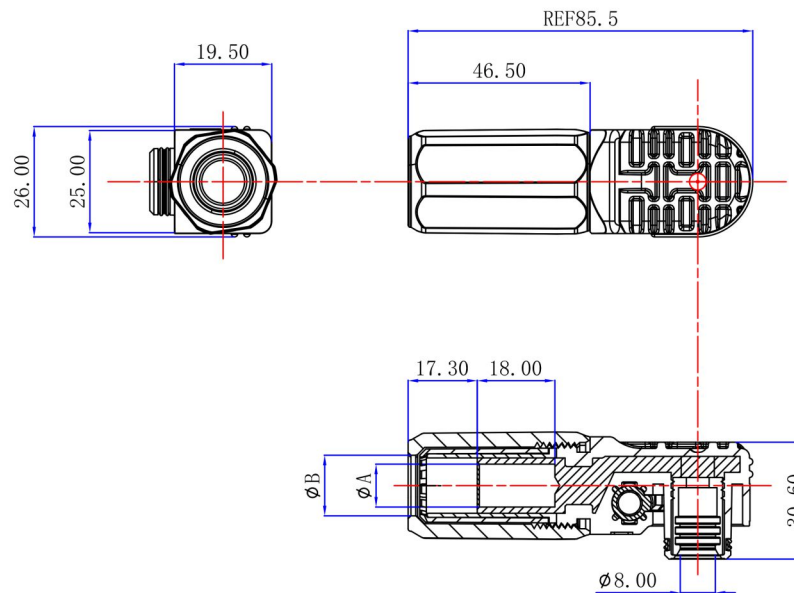
Size

Disclaimer

The information in this specification is subject to change without notice. Please confirm the latest version before use. Technical parameters are for reference only, and sufficient testing and verification should be conducted in actual applications.