

N Type Connector Jack Straight Crimp Panel Mount Bulkhead 50ohm - RHT-614-0212

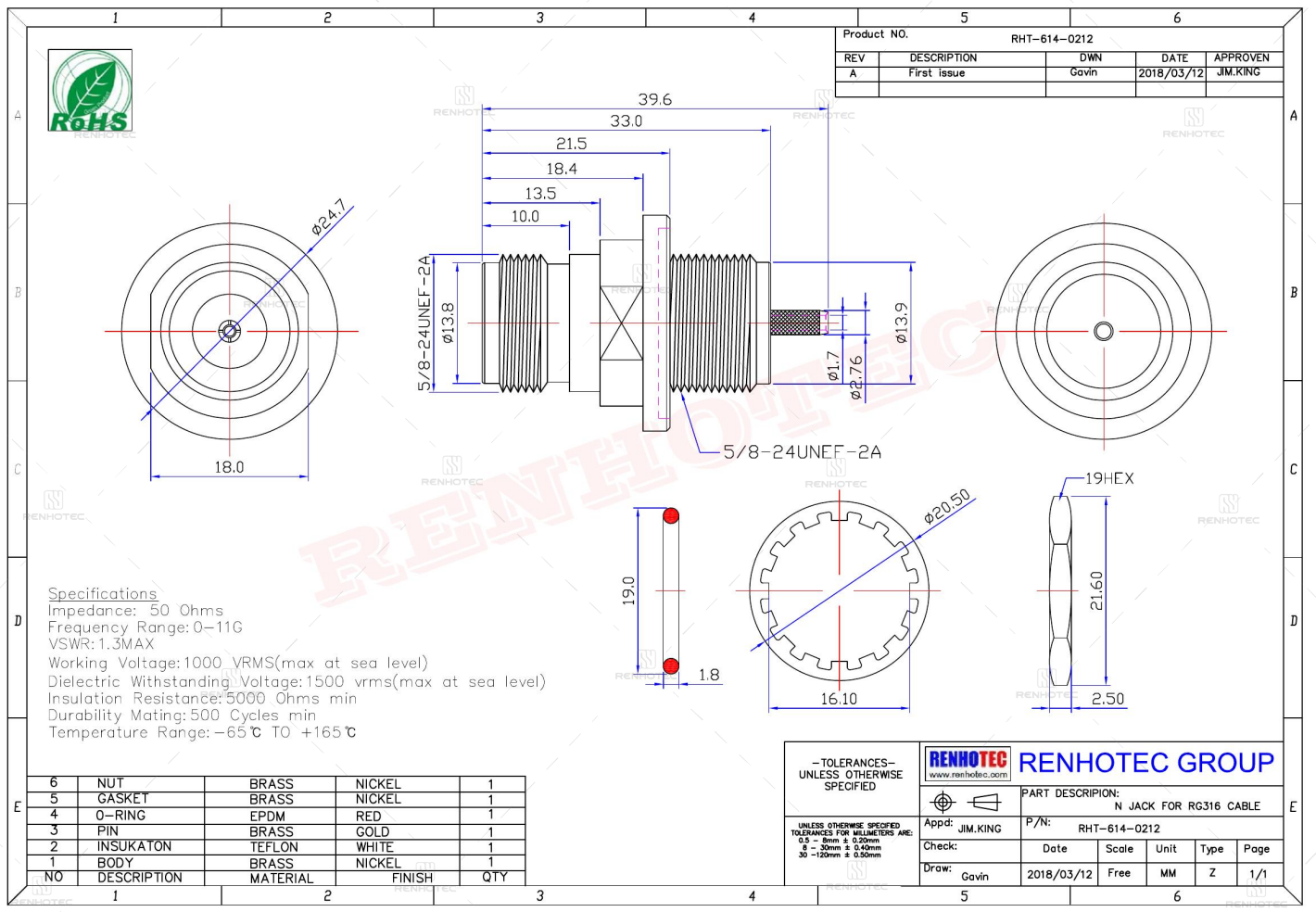

Drawing



Basic Information

Connector Type	Jack
Contact Termination Style	Crimp
Fastening Type	Threaded
Mounting Feature	Bulkhead
Mounting Type	Panel Mount
Number of Ports	1
Orientation	Straight
Shield Termination	Crimp

Mechanical Specification

Contact Retention	6 lbs min.
Coupling Nut Retention	30 in-lbs. MIN
Mating Durability	≥ 500 Cycles

Environmental Specification

Corrosion Resistance	MIL-STD-202 Meth. 101
Ingress Protection	IP65
Operating Temperature	-65°C to +165°C
Vibration	MIL-STD-202 Meth. 204

Electrical Specification

Dielectric Withstanding Voltage	2500 V rms
Withstand Voltage	1500V RMS Max

Material and Finish

Component Description	Material	Finish
Shell	Copper Alloy	Nickel Plated
Insulator	Teflon White	
Contact	Brass	Gold Plated

Impedance Testing

Impedance	50Ω
-----------	-----

Frequency & VSWR Test Report

Frequency Range	DC-11 GHz
VSWR	R/A type ≤ 1.5MAX, Straight type ≤ 1.3 MAX

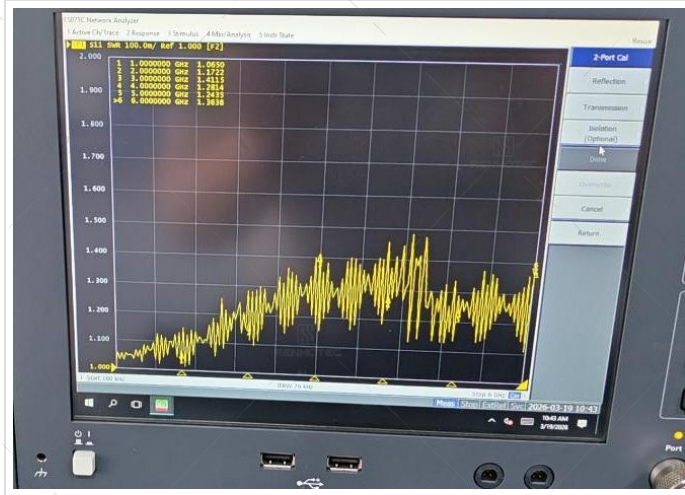

Contact Resistance Test

Contact Type	Female Pin
Center Contact Resistance	≅ 1.0 MΩ (Milliohms Max.)
Outer Contact Resistance	≅ 0.2 MΩ (Milliohms Max.)



Working Voltage & Insulation Resistance Test

Working Voltage	1000 V rms
Insulation Resistance	$\geq 5 \times 10^3 M\Omega$ (Megohms MIN.)



Version History

REV	Date	Revise Contents	Drafter	Approver
A.0	2026.6.18	The initial formulation	Esther	Joson

Disclaimer

The information in this specification is subject to change without notice. Please confirm the latest version before use. Technical parameters are for reference only, and sufficient testing and verification should be conducted in actual applications.