

MCX Connector Male Crimp RG178 Cable Type 50ohm - RHT-617-1013

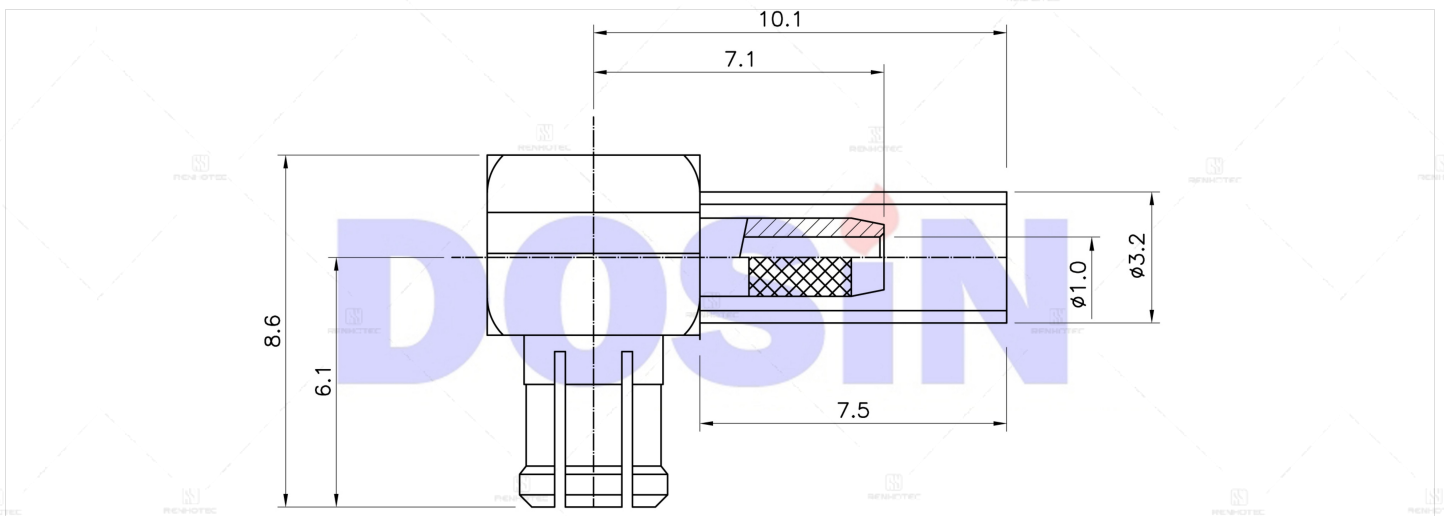

Drawing



Basic Information

Cable Type	RG178
Connector Type	Plug
Mounting Type	Cable Mount
Number of Ports	1
Orientation	Right Angle
Fastening Type	Push-Pull

Mechanical Specification

Contact Termination Style	Crimp
Mating Durability	≥ 500 Cycles

Material Specification

Shield Termination	Crimp
--------------------	-------

Environmental Specification

Temperature Range	-65°C to +165°C
Corrosion Resistance	MIL-STD-202 Meth. 101
Vibration	MIL-STD-202 Meth. 204

Material and Finish

Component Description	Material	Finish
Shell	Copper Alloy	Gold Plated
Insulator	Teflon White	
Center Contact	Brass	Gold Plated

Impedance Testing

Impedance	50 ohm
-----------	--------

Frequency & VSWR Test Report

Frequency Range	6GHz
VSWR	≤1.15 (DC to 4 GHz), ≤1.40 (4 to 6 GHz)

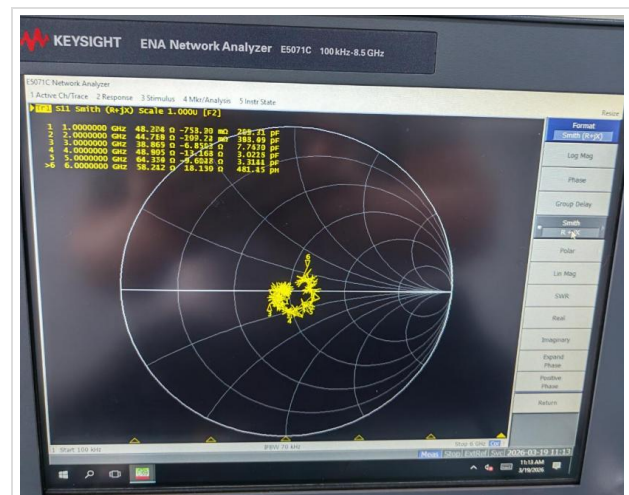
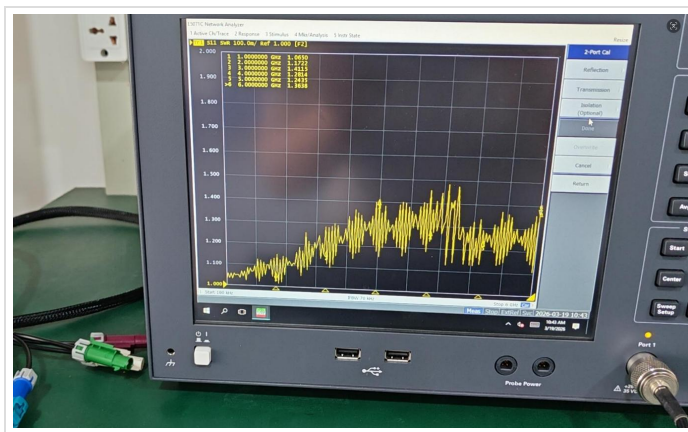

Contact Resistance Test

Contact Type	Male Pin
Center Contact Resistance	5 MΩ Min
Outer Contact Resistance	1 MΩ Min



Working Voltage & Insulation Resistance Test

Rated Voltage	500 Volts RMS Max Continuous
Dielectric Withstanding Voltage	1000 VRMS Max
Insulation Resistance	500MΩ Min



Version History

REV	Date	Revise Contents	Drafter	Approver
A.0	2026.5.13	The initial formulation	Esther	Joson

Disclaimer

The information in this specification is subject to change without notice. Please confirm the latest version before use. Technical parameters are for reference only, and sufficient testing and verification should be conducted in actual applications.