



J30J Metal Shell 9pin Pre-Wired Micro-D MIL-Spec Male Connector, L=30cm J30JA-9ZKN-J 7g

Part Number:

**J30JA-9ZKN-J**

### Basic Information

Connector Type	Plug
Orientation	Straight
Contact Type	Male
Number of Cores	9
Number of Interface Rows	2
Contact Spacing	1.27mm
Mounting Type	Panel Mount
Contact Termination	Crimp
Wire Length	30cm
Wire Gauge	0.1mm <sup>2</sup> ~0.15mm <sup>2</sup>
Color	Primary Color

### Material Specification

Housing Material	Aluminum Alloy
Housing Plating	Nickel-plated
Contacts Plating	Gold-plated

### Electrical Specification

Rated Current	3A
Withstand Dielectric Voltage	800V
Contact Resistance	≤ 10mΩ
Insulation Resistance	≥ 5000MΩ

### Environmental Specification

Operating Temperature	-55°C ~ +125°C
-----------------------	----------------

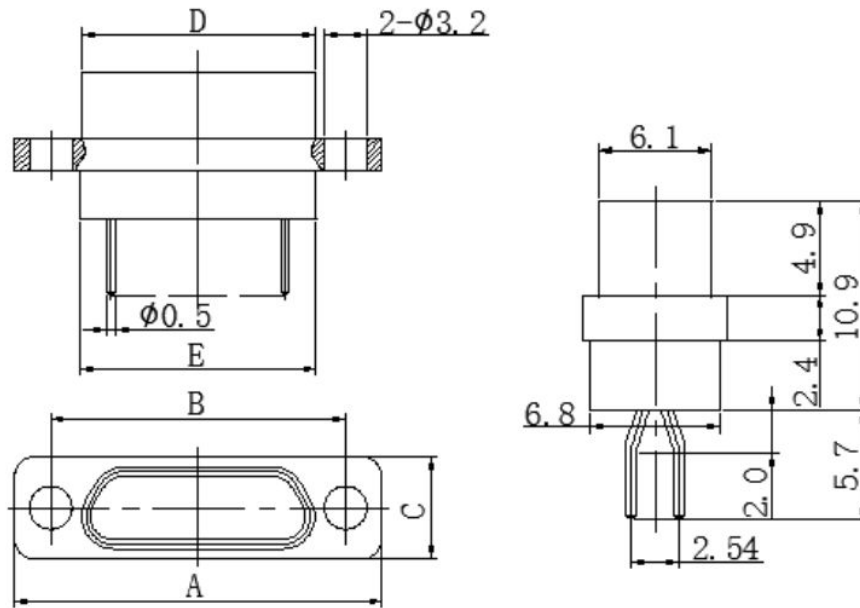
**Size**

**How to Order**

J30 — J — X- — X — TJ / ZK — X — X- — X

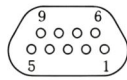
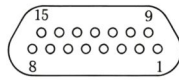
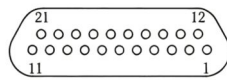
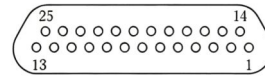
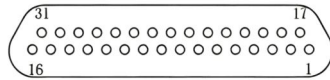
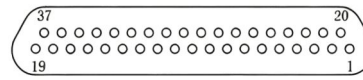
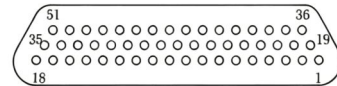
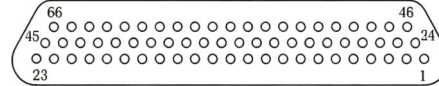
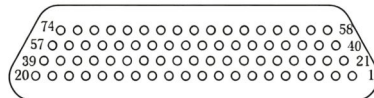
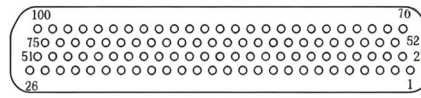
Code	Description	Options
<b>J30</b>	Series / Basic Type	Micro-D Rectangular Connector (MIL-DTL-83513 Equivalent)
<b>J</b>	Shell Material	<b>J</b> — Metal Shell
<b>X-</b>	Series Modification	<b>Blank</b> — Basic Type <b>D</b> — M2-6H Mounting Holes <b>M1</b> — Glass Sintered Hermetic <b>A</b> — Quick-lock <b>M</b> — Rubber Seal <b>S</b> — Stainless Steel Shell
<b>X</b>	Number of Contacts	9, 15, 21, 25, 31, 37, 51, 66, 69, 74, 100 pins
<b>TJ / ZK</b>	Connector and Contact Type	<b>TJ</b> — Plug with Male Pins <b>ZK</b> — Receptacle with Female Sockets
<b>X</b>	Termination Style	<b>Blank</b> — Crimp <b>N</b> — Straight PCB (Through-hole) <b>S</b> — Solder Cup <b>W</b> — Right Angle PCB
<b>X-</b>	Locking Hardware Type	<b>K, L</b> — Free-end Locking Assembly <b>P, V</b> — Fixed-end Locking Assembly
<b>X</b>	Modification Code	<b>A</b> — Shielding Sleeve (Crimp only) <b>D</b> — Anti-rotation Structure (Fixed-end only) <b>J</b> — 1.27mm x 2.54mm PCB Grid Spacing <b>C</b> — Vertical Wire Exit (Crimp only) <b>AD</b> — Combination of A and D <b>Q, Q8</b> — Widened Flange

**Contact Layout**

**J30J-9 Pin**

**J30J-15 Pin**

**J30J-21 Pin**

**J30J-25 Pin**

**J30J-31 Pin**

**J30J-37 Pin**

**J30J-51 Pin**

**J30J-66 Pin**

**J30J-74 Pin**

**J30J-100 Pin**
**Disclaimer**

The information in this specification is subject to change without notice. Please confirm the latest version before use. Technical parameters are for reference only, and sufficient testing and verification should be conducted in actual applications.