



Energy Battery Storage Connector Right Angle 250A
Black 70mm2 Unshielded Cable

Part Number:

FSP800180TW-70U0B2RH



Basic Information

Connector Type	Plug
Orientation	Right Angle
Color	Black
Wire Gauge	70mm2
Contact Termination	Crimp
Mounting Type	Cable Mount
Terminal	8mm
Key	W

Material Specification

Shell Material	Nylon
Contact Finish	Silver Plating
Contact Material	T2

Environmental Specification

Operating Temperature	-40°C to +125°C
Flammability	UL94 V-0
Ingress Protection	IP67

Electrical Specification

Rated Current	250A
Rated Voltage	1000V

Size

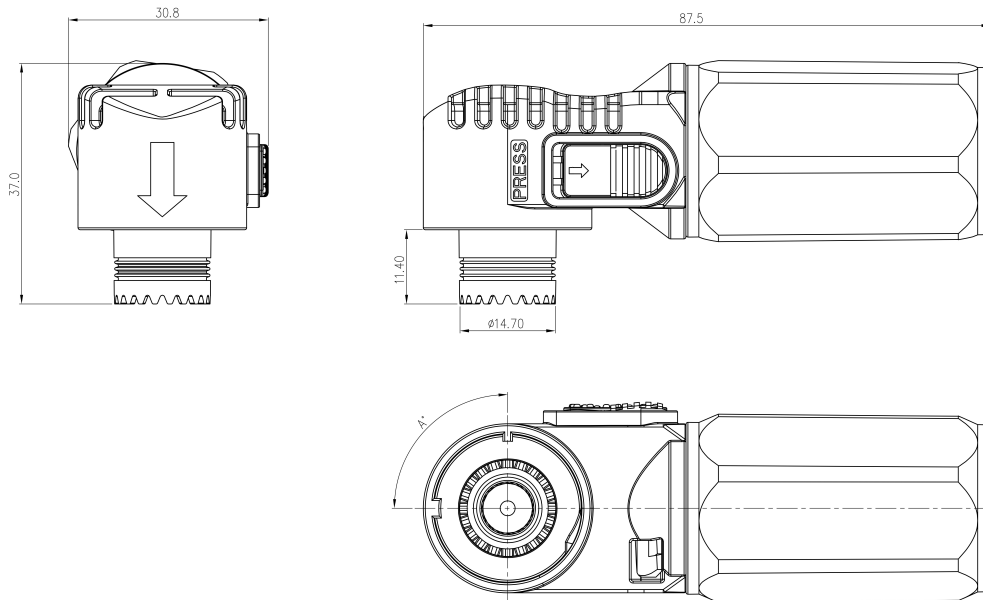

Disclaimer

The information in this specification is subject to change without notice. Please confirm the latest version before use. Technical parameters are for reference only, and sufficient testing and verification should be conducted in actual applications.