



Energy Battery Storage Connector 250A Socket Busbar Terminal(M8 screw) 8.0mm Orange

Part Number:

FSP240180CZ-UM8A1RH



Basic Information

Connector Type	Socket
Orientation	Straight
Color	Orange
Contact Termination	Crimp
Mounting Type	Cable Mount
Mating Cycles	>500
Terminal	8mm

Material Specification

Shell Material	Nylon
Contact Finish	Silver Plating

Environmental Specification

Operating Temperature	-40°C to +125°C
Flammability	UL94 V-0
Ingress Protection	IP67

Electrical Specification

Rated Current	250A
Rated Voltage	1000V
Insulation Resistance	≥1000MΩ

Size

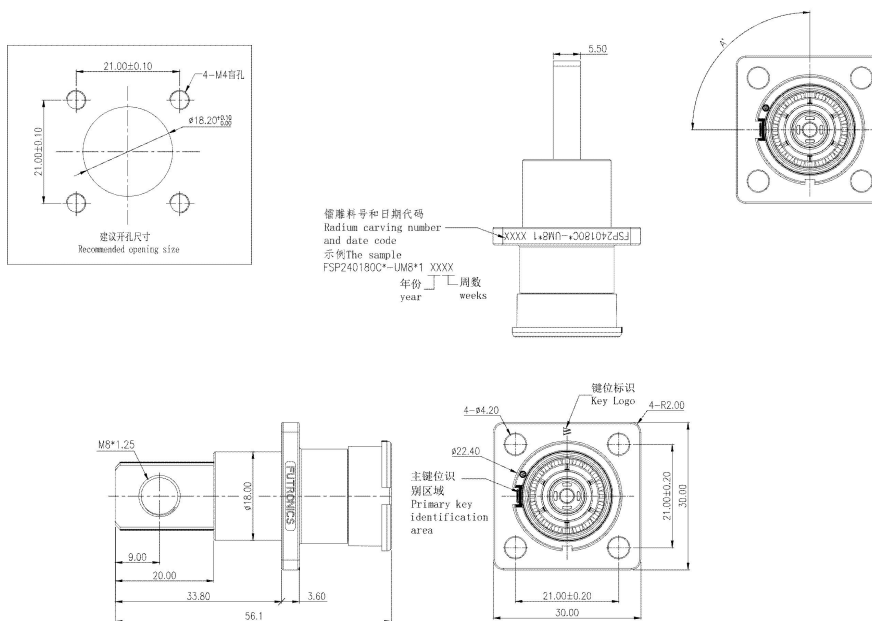

Disclaimer

The information in this specification is subject to change without notice. Please confirm the latest version before use. Technical parameters are for reference only, and sufficient testing and verification should be conducted in actual applications.