



Energy Battery Storage Connector 200A Plug Right Angled 50mm² Unshielded Cable 8mm Black

Part Number:

FCC0850-F1BR

Basic Information

Connector Type	Plug
Orientation	Right Angle
Color	Black
Wire Gauge	50mm ²
Contact Termination	Crimp
Mounting Type	Cable Mount
Mating Cycles	>500
Terminal	8mm

Material Specification

Shell Material	Nylon
Contact Finish	Silver Plating

Environmental Specification

Operating Temperature	-40°C to +125°C
Flammability	UL94 V-0
Ingress Protection	IP67

Electrical Specification

Rated Current	200A
Rated Voltage	1000V
Insulation Resistance	≥1000MΩ

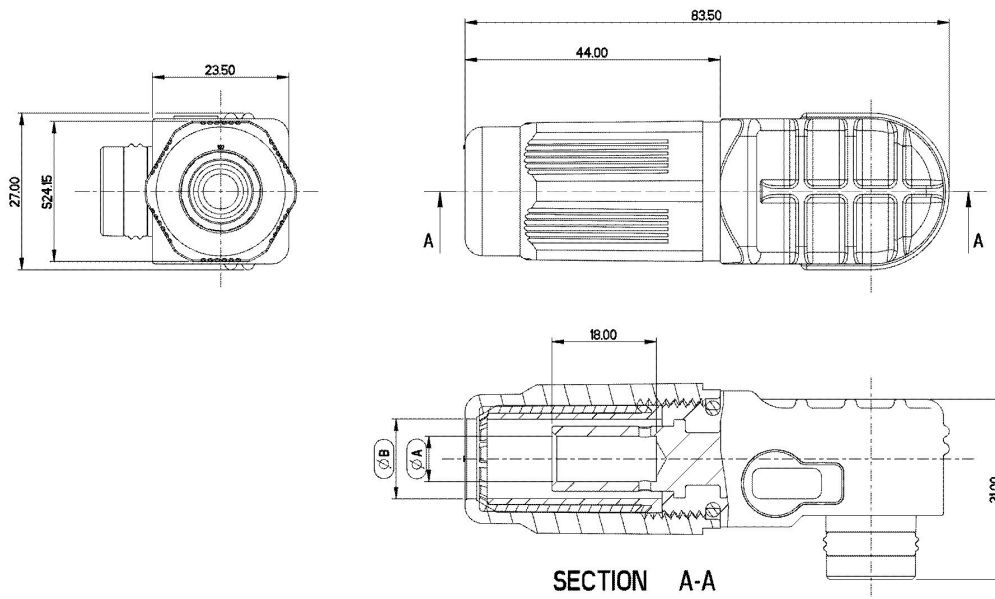
Size

Disclaimer

The information in this specification is subject to change without notice. Please confirm the latest version before use. Technical parameters are for reference only, and sufficient testing and verification should be conducted in actual applications.