



Energy Battery Storage Connector 150A Plug Right Angled 35mm² Unshielded Cable 8mm Red

Part Number:

FCC0835-F1RR



Basic Information

Connector Type	Plug
Orientation	Right Angle
Color	Red
Wire Gauge	35mm ²
Contact Termination	Crimp
Mounting Type	Cable Mount
Mating Cycles	>500
Terminal	8mm

Material Specification

Shell Material	Nylon
Contact Finish	Silver Plating

Environmental Specification

Operating Temperature	-40°C to +125°C
Flammability	UL94 V-0
Ingress Protection	IP67

Electrical Specification

Rated Current	150A
Rated Voltage	1000V
Insulation Resistance	≥1000MΩ

Size

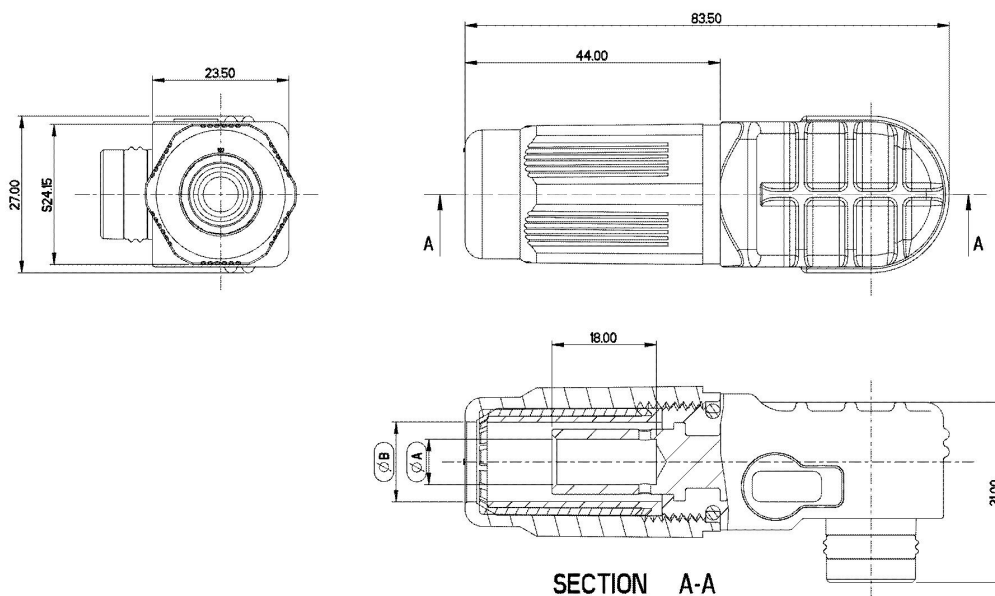

Disclaimer

The information in this specification is subject to change without notice. Please confirm the latest version before use. Technical parameters are for reference only, and sufficient testing and verification should be conducted in actual applications.