



M9 Male Straight Solder Cable Front Fastened Connector

Part Number:



Basic Information

Connector Type	Socket
Contact Termination	Solder Cup
Contact Type	Male Pin
Fastening Type	Threaded
Key	A
Mounting Feature	Front Fastened
Mounting Type	Panel Mount
Number of Positions	2 Pin, 3 Pin, 4 Pin, 5 Pin, 6 Pin, 7 Pin, 8 Pin
Orientation	Straight
Shell Size	M9

Material Specification

Contact Finish	Gold Plating
Contact Material	Copper Alloy
Insulation Material	PA66
Shell Finish	Zinc Plating
Shell Material	Copper Alloy

Electrical Specification

Shielding	Unshielded
-----------	------------

Environmental Specification

Ingress Protection	IP67
Operating Temperature	-25°C ~ + 85°C

Mechanical Specification

Mechanical Operation	>500 Mating Cycles
----------------------	--------------------

Contact Layout

Number of positions

2

3

4

5

6

7

8

Insert arrangement
(Female)

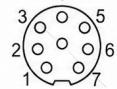
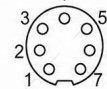
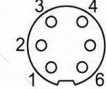
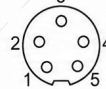
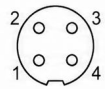
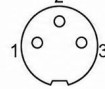
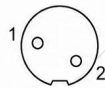

Insert arrangement
(Male)

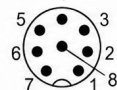
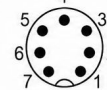
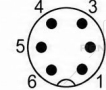
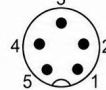
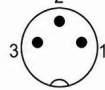
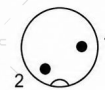

Size

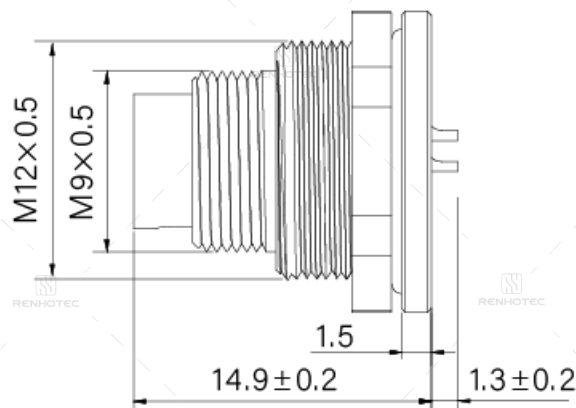

Disclaimer

The information in this specification is subject to change without notice. Please confirm the latest version before use. Technical parameters are for reference only, and sufficient testing and verification should be conducted in actual applications.