



M23 Female Plug Straight Signal Cable Metal Shell Field Wireable Connector

Part Number:



Basic Information

Connector Type	Plug
Contact Orientation	Clockwise, Counterclockwise
Contact Termination	Outer Screw
Contact Type	Female Pin
Fastening Type	Threaded
Mounting Type	Cable Mount
Number of Positions	12 Pin, 17 Pin, 19 Pin, 6 Pin, 7 Pin, 9 Pin
Orientation	Straight
Shell Size	M23

Material Specification

Contact Finish	Gold Plating
Contact Material	Copper Alloy
Insulation Material	PA66
Shell Finish	Zinc Plating
Shell Material	Copper Alloy

Electrical Specification

Shielding	Shield
-----------	--------

Environmental Specification

























Ingress Protection	IP67
Operating Temperature	-25°C ~ + 85°C

Mechanical Specification

Mechanical Operation	>500 Mating Cycles
----------------------	--------------------

Contact Layout

Specification

Number of positions	6	7	9	12	17	19
Female E layout						
Male E layout						
Female P layout						
Male P layout						

Size

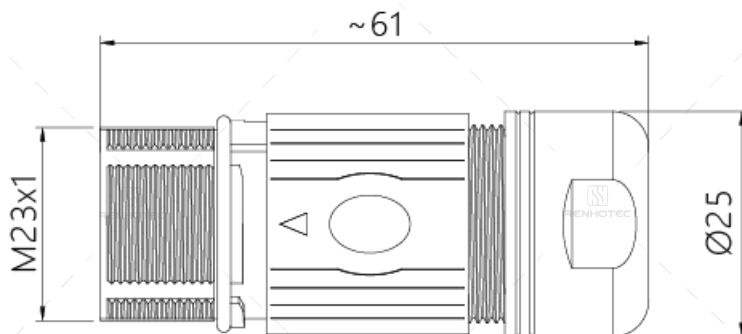

Disclaimer

The information in this specification is subject to change without notice. Please confirm the latest version before use. Technical parameters are for reference only, and sufficient testing and verification should be conducted in actual applications.