

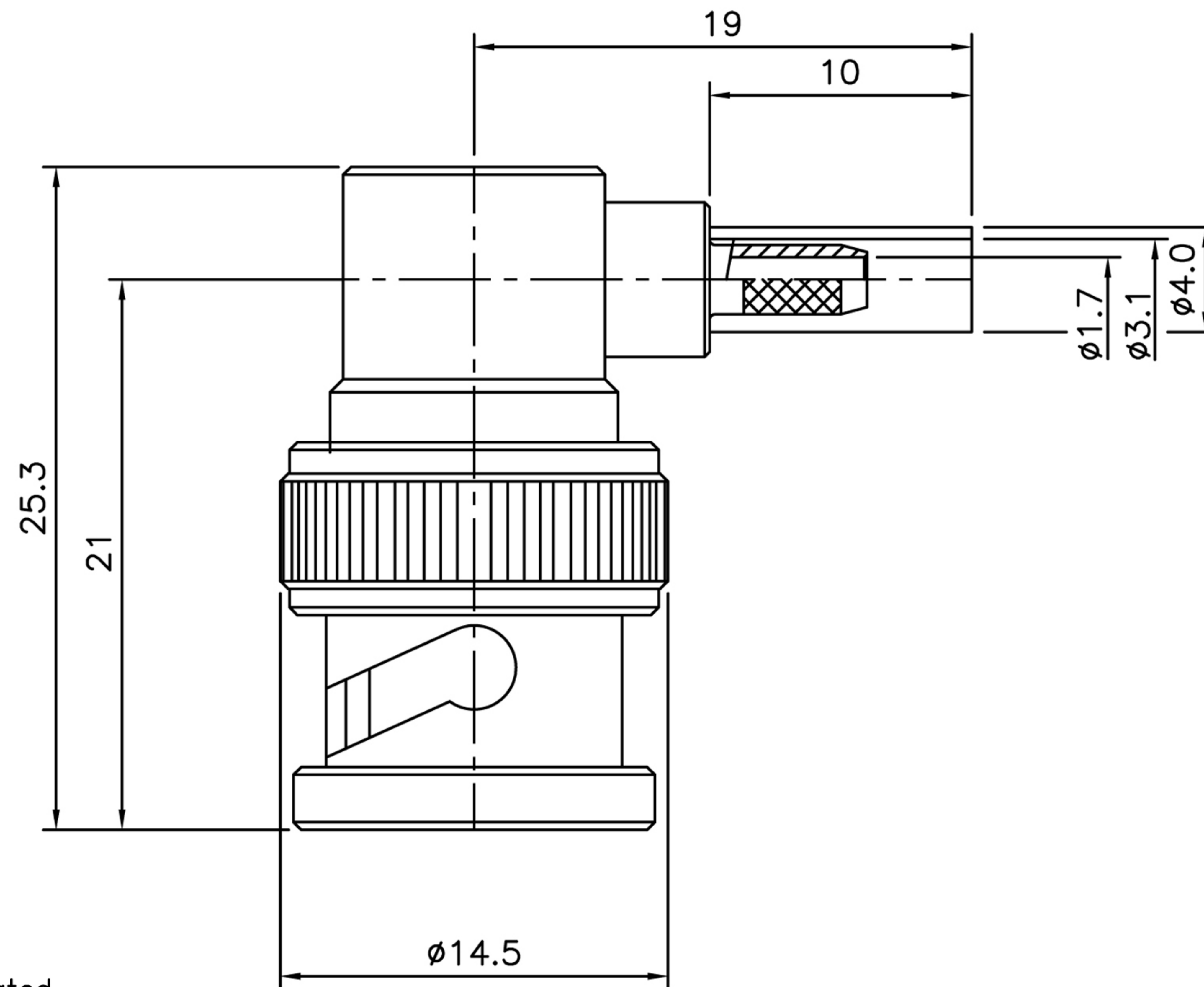

Product NO.	Renhotec-610-0212			
REV	DESCRIPTION	DWN	DATE	APPROVEN
A	First issue	Mr. Wang	2017/2/22	John kine



Connector parts	Materials	Finish
Coupling Cap	Zinc	Nickel Plated
Body	Brass	Nickel Plated
Center contact	Brass	Gold Plated
Ferrule	Brass	Nickel Plated
Insulator	PTFE	-

NOTE :		Tolerance	0-6	±0.10
DRAWN Zelin. Zhang 2017/2/22			6-30	±0.20
CHECKED		View	30-120	±0.30
APPROVALS <i>John Kine</i> 2017/2/22			Angular	±2°
		UNIT	MM	
		SCALE	1:1	



RENHOTEC GROUP

Name: BNC Right Angle Plug for Cable-RG316

SIZE A	Product NO. RHT-610-0212	REV B
DateTime 2017/2/22	CAD FILE D/company drawings/BD	SHEET: 1 OF 1